



ÖZGÜLLER
ALUMINIUM SYSTEMS



Bioklimatik Sistem / Bioclimatic System
Kış Bahçesi / Winter Garden

Giriş Introduction

Bioklimatik sistem, otomatik kendi eksenine paralelde hareket ederek geriye toplanabilen bir sistemdir. Özel ve ticari kapsamlı uygulama alanlarında, projenize özel çözümler üreterek maksimum kullanılabilirlik ve konforla beraber mekanlarınıza şıklık sağlar.

Modern tasarımın yanı sıra farklı otomatik sistem (yağmur, rüzgar sensörleri vb.) eklenmesine, ısıtıcı ve led aydınlatma uygulamasına imkan vermektedir.

Bioklimatik Sistem açık, yarı açık alanlarda, evler, turistik tesisler, restoran ve cafe gibi alanlarda kullanılmaktadır.

This system be retracted by moving automatically parallel to its own axis also system can collect back. It provides elegance to your spaces with maximum usability and comfort by producing special solutions for your project in private and commercial application areas.

In addition to the modern design, it allows the addition of different automatic systems (rain, wind sensors, etc.). Thanks to that system have heater and led lighting.

Bioclimatic system have places in open, semi-open areas, houses, tourist facilities, restaurants and in areas such as cafes.



Tasarım Design



Bioklimatik sistem çalışma sırasında oluşabilecek gürültüyü minimize eder. Lamellerin hareketi lineer motorlar sayesinde 105° olur. Lamellerin serbest hareketine izin veren motorlu sistem, sistemin iç kısmında yer almaktadır. Conta kullanımı sayesinde lamellerde kaynaklanan gürültünün engellenmesi sağlanır ve lamellerin arasından sızabilecek suyun önüne geçilir. Lameller kayış sayesinde bir tarafta toplanır. Oluğun iç kısmında led kanalları bulunmaktadır. Led ışığı RGB sayesinde değiştirilebilir. Ayrıca dimmer sayesinde ışık ayarı yapılabilir. Sistemin yan yana getirilmesiyle geniş alanlarda kullanılmaktadır.

The bioclimatic system minimizes the noise that may occur during operation. The movement of the lamellas is 105° thanks to the linear motors. The motorized system that allows the free movement of the lamellas is located inside the system. Thanks to the use of gaskets, the noise caused by the lamellas is prevented and the water that can leak through the lamellas is prevented. The lamellas are collected on one side thanks to the strap. There are led channels in the inner part of the groove. The LED light can be changed thanks to RGB. In addition, the light can be adjusted thanks to the dimmer. It is used in large areas by bringing the system side by side.

Opsiyonel Ürünler Optional Products

Çeşitli seçilebilir otomatik sistemler arasından seçim yapma imkanı:

- Led ışığı
- Infrared ısıtma sistemi
- Verici ve merkezi kontrol
- Akıllı telefon kontrolü
- Güneş sensörü
- Rüzgar sensörü
- Yağmur sensörü

Choose from a variety of automatic options Possibility systems:

- led lightning
- Infrared heating
- Transmitter and central control
- Smartphone control
- Temperature sensor
- Snow sensor
- Rain sensor

Lamel Hareketi Lamella Movement

Lamellerin 0° ile 105° arasında serbest dönüşü sistemin maksimum havalandırılmasını sağlar.

Free rotation of the lamellas between 0° and 105° provides maximum ventilation of the system.



0°

Lamellerin kapalı kalması her türlü hava koşulundan koruma sağlar.

Keeping the lamellas closed provides protection from all weather conditions.



5°

Yağmur veya kar yağıyor olsa bile alanın havalandırılmasına izin verir.

It allows ventilation of the area even if it is raining or snowing.

Lamel Hareketi Lamella Movement

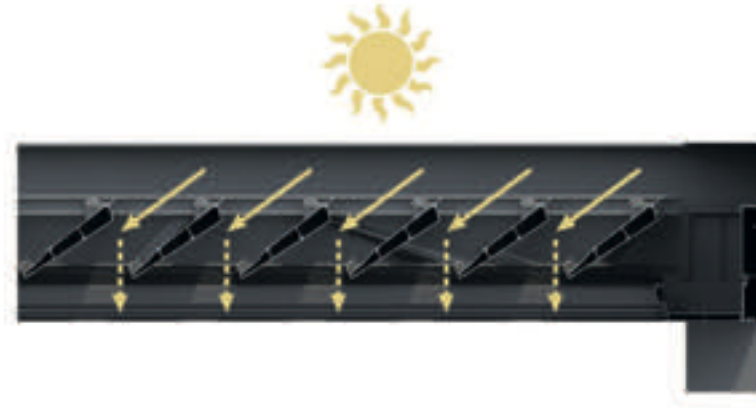

45°

Güneş ışığının girmesine izin verir aydınlatmayı kontrol eder.

Allows sunlight to enter and controls lighting.

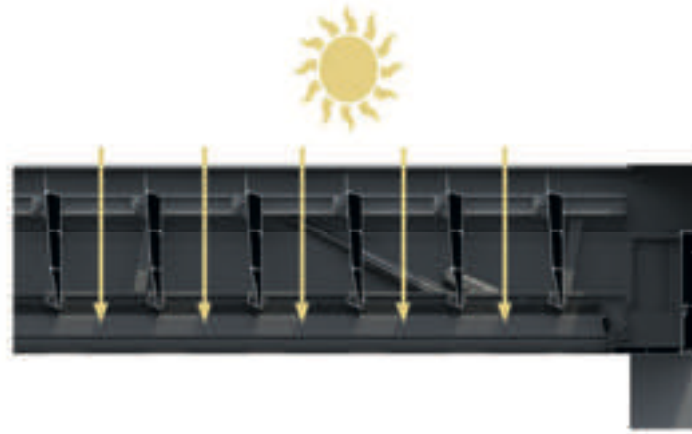

105°

Güneş ışığının tam olarak kullanılmasına izin verir.

Allows full use of sunlight.

Yağmur Suyu Drenaj Sistemi Rainwater Drainage System

Bioklimatik sistem yağmur suyunu toplayacak şekilde tasarlanmıştır. Su, lamellerden yan oluklara yönlendirilir. Toplanan su ayağın içinden dışarıya aktarılır. Yağmur suyunun dışarı aktarılması için oluğa ve ayağa kертme işlemi uygulanır.

The bioclimatic system is designed to collect rainwater. Water is directed through the lamellas into the side grooves. The collected water is transferred from the inside of the column to the outside. In order to transfer the rain water to the outside, the cutting process is applied to the gutter and the column.



Yağmur Suyu Drenaj Sistemi Rainwater Drainage System

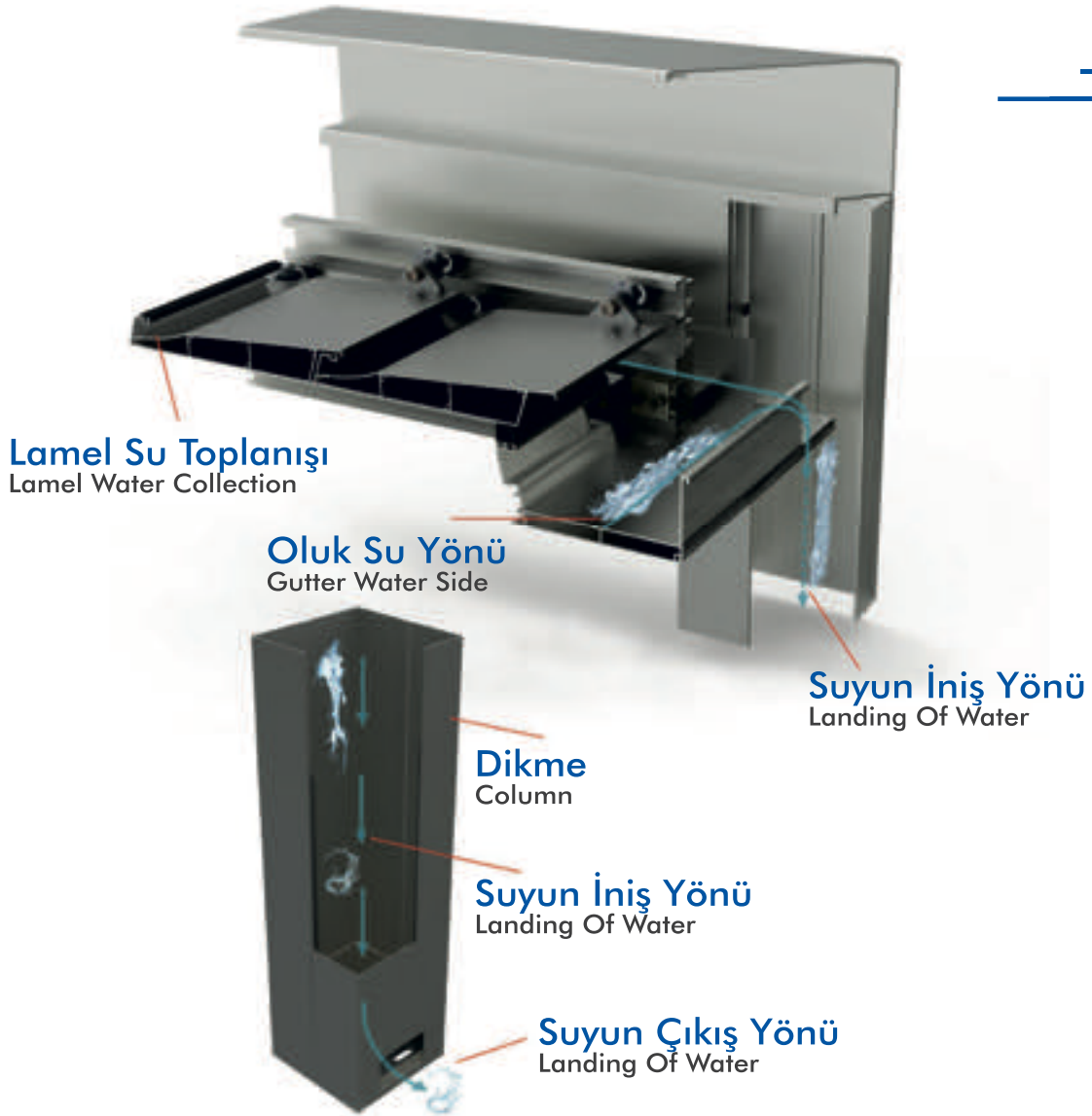

İçindekiler

Index

Profil Kesitleri Profile Sections	8
Bioklimatik Sistem Profilleri Profiles Of Bioclimatic System	9
Tipoloji Typology	12
Aksesuarlar Accessories	16
Kurulum Talimatları Installation Instructions	24

Profil Kesitleri / Profile Sections

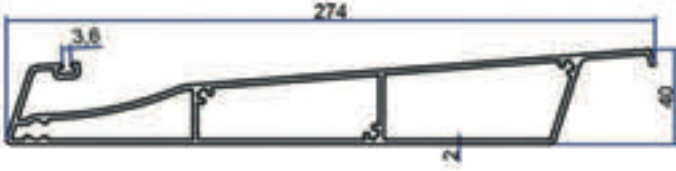

Profile No	kg/m
BIO-1805	3,85



Profile No	kg/m
BIO-1801	3,7

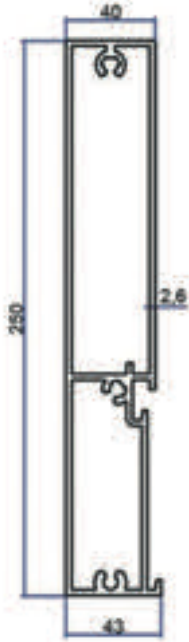

Profile No	kg/m
BIO-1802	5,05

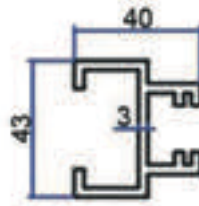

Profile No	kg/m
BIO-1804	1,3

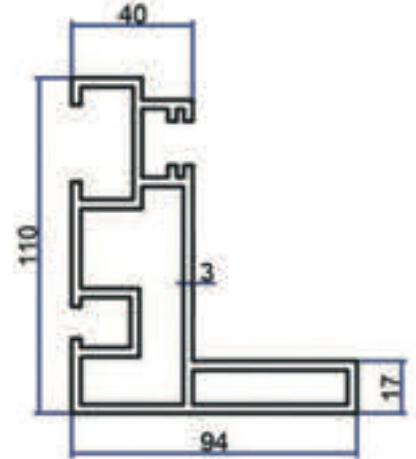

Profile No	kg/m
BIO-1803	4,25



Profile No	kg/m
BIO-1807	0,92

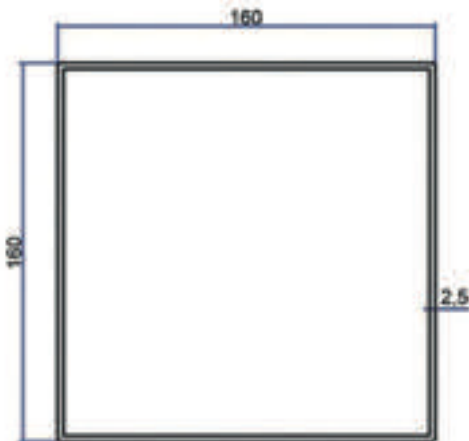

Profile No	kg/m
BIO-1808	4,9

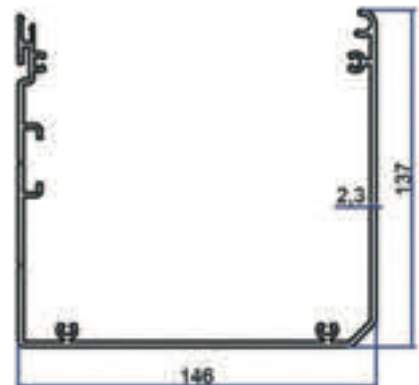

Profile No	kg/m
BIO-1806	3,4

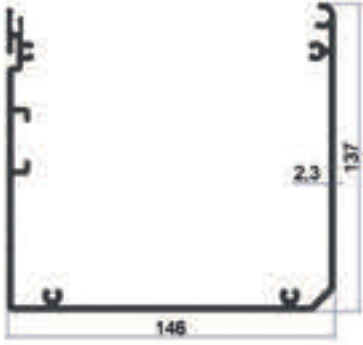

PROFİL PROFİLE	BIO-1806	İSMİ NAME	MOTOR KUTUSU ENGINE BOX	AĞIRLIK WEIGHT	3,4 kg/m
--------------------------	----------	---------------------	-----------------------------------	--------------------------	----------



PROFİL PROFİLE	BIO-1807	İSMİ NAME	MOTOR KUTUSU KAPAĞI ENGINE BOX COVER	AĞIRLIK WEIGHT	0,92 kg/m
--------------------------	----------	---------------------	--	--------------------------	-----------

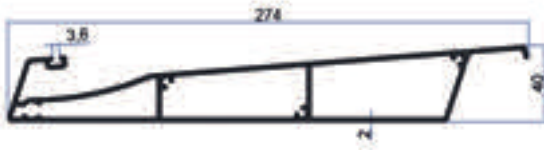

PROFİL PROFİLE	BIO-1805	İSMİ NAME	LAMEL LAMELLA	AĞIRLIK WEIGHT	3,85 kg/m
--------------------------	----------	---------------------	-------------------------	--------------------------	-----------

Profiller / Profiles

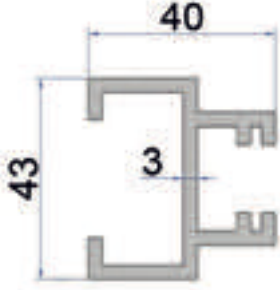

PROFİL PROFILE	BIO-1804	İSMİ NAME	RAY ÜST EK RAIL TOP ADD	AĞIRLIK WEIGHT	1,3 kg/m
--------------------------	----------	---------------------	-----------------------------------	--------------------------	----------

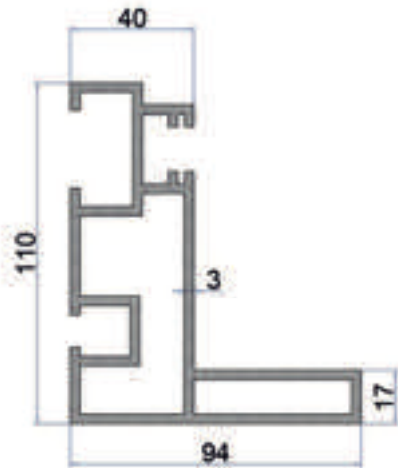

PROFİL PROFILE	BIO-1803	İSMİ NAME	RAY RAIL	AĞIRLIK WEIGHT	4,25 kg/m
--------------------------	----------	---------------------	--------------------	--------------------------	-----------

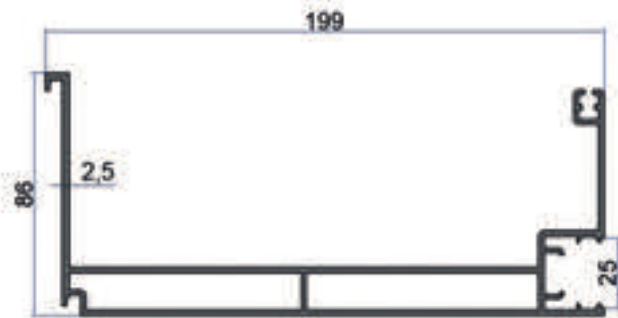

PROFİL PROFILE	BIO-1801	İSMİ NAME	OLUK GUTTER	AĞIRLIK WEIGHT	3,7 kg/m
--------------------------	----------	---------------------	-----------------------	--------------------------	----------

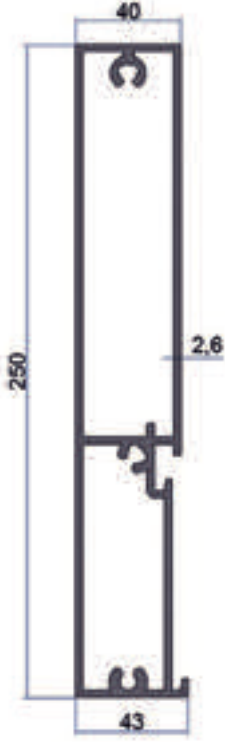

PROFİL PROFİLE	BIO-1802	İSMİ NAME	40X250 OLUK DİKME 40X250 GUTTER SEWING	AĞIRLIK WEIGHT	5,05 kg/m
--------------------------	----------	---------------------	--	--------------------------	-----------

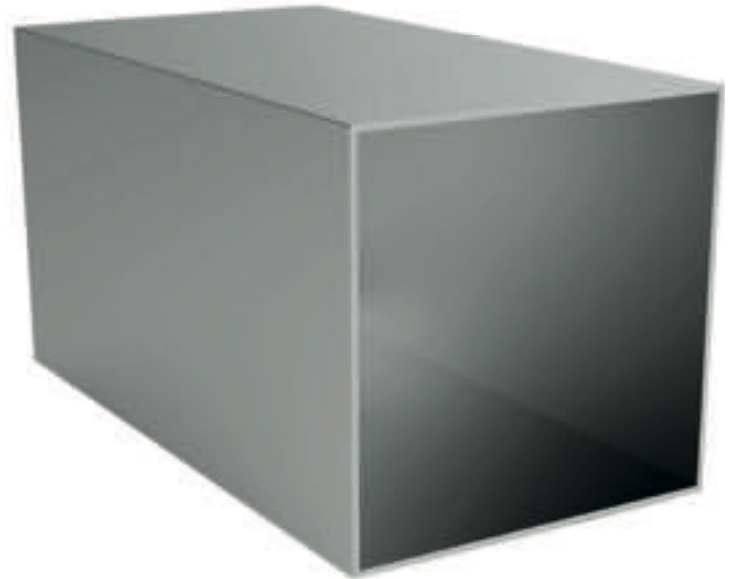
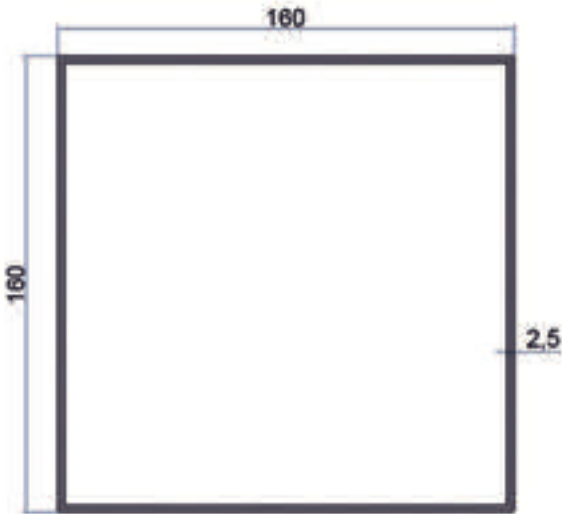

PROFİL PROFİLE	BIO-1808	İSMİ NAME	160X160 DİKME 160X160 COLUMN	AĞIRLIK WEIGHT	4,9 kg/m
--------------------------	----------	---------------------	--	--------------------------	----------

Tipoloji Tipology



- 4 Ayaklı 1 Sistem
- 1 System With 4 Legs



- 6 Ayaklı 2 Sistem
- 2 System With 6 Legs

Tipoloji Tipology



- 12 Ayaklı 6 Sistem
- 6 System With 12 Legs



- Ayaksız 1 Sistem
- 1 System Without leg

Tipoloji Tipology



- 2 Ayaklı 1 Sistem
- 1 System With 2 Legs



- 3 Ayaklı 2 Sistem
- 2 System With 3 Legs

ÖN AÇILIM ÖLÇÜSÜ VE PANEL SAYISI Front Opening Size and Number of Panels

Panel Sayısına Göre Açılım Ölçüleridir.

These are the dimensions of the opening according to the number of panels.

5 LAMEL	1,550 Metre	17 LAMEL	4,378 Metre
6 LAMEL	1,780 Metre	18 LAMEL	4,614 Metre
7 LAMEL	2,016 Metre	19 LAMEL	4,850 Metre
8 LAMEL	2,250 Metre	20 LAMEL	5,086 Metre
9 LAMEL	2,488 Metre	21 LAMEL	5,322 Metre
10 LAMEL	2,725 Metre	22 LAMEL	5,558 Metre
11 LAMEL	2,960 Metre	23 LAMEL	5,795 Metre
12 LAMEL	3,197 Metre	24 LAMEL	6,030 Metre
13 LAMEL	3,433 Metre	25 LAMEL	6,267 Metre
14 LAMEL	3,670 Metre	26 LAMEL	6,503 Metre
15 LAMEL	3,905 Metre	27 LAMEL	6,740 Metre
16 LAMEL	4,142 Metre	28 LAMEL	6,975 Metre

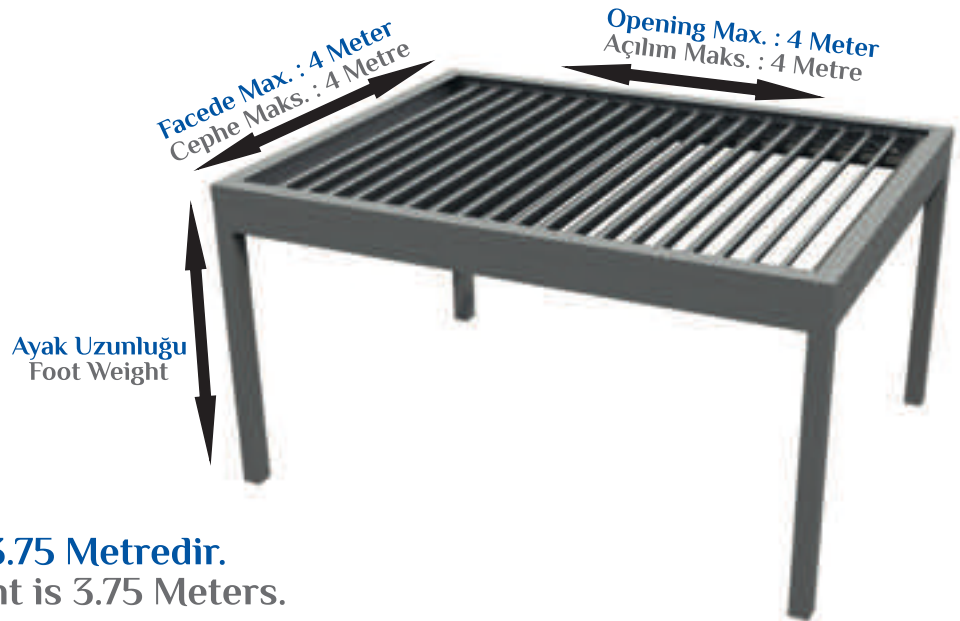

Max Cephe Uzunluğu 3.75 Metredir.
The Max. Facade Length is 3.75 Meters.











BIO-2000 Motor Takım Seti

BIO-2000 Engine Tool Set

ÜRÜN KODU Product Code	ÜRÜN RESMİ Product Image	ÜRÜN AÇIKLAMASI Product Description	ADET Piece
BIO-2001		Motor Kutusu Yan Kapak Engine Box Side Cover	2
BIO-2002		Rulman Yatağı Rulman Yatağı	1
BIO-2003		Rulman Kelepçesi Rulman Clamp	1
BIO-2009		Kayış Yön Verme Aparatı Belt Directions	2
BIO-2012		Makara Pimi Roller Pin	4
BIO-2010		Dişi Makara Female Roller	2
BIO-2011		Erkek Makara Male Rolller	2
BIO-2013		Sekizgen Dişli Octagonal Gear	2
BIO-2506		M6X12 Setskur M6X12 Setskur	4
BIO-2006		M8X20 H.B İnbus Civata M8X20 İnbus Bolt	8
BIO-2007		M5X12 İnbus Civata M5X12 İnbus Bolt	1
BIO-2008		M8 Fiber Somun M8 Fiber Nut	14
BIO-2508		4.8x19 YSB BOMBE Baş Akıllı Vida 4.8x19 YSB BOMB Smart Screw	8
BIO-2512		Plastik Pul Plastik Washer	2
BIO-2004		Rulman Roller	1
BIO-2005		Sekizgen Boru Başı Octagonal Pipe Head	1

BIO-2200 Ön Çekici Takım Seti

BIO-2200 Front Drawer Kit

ÜRÜN KODU Product Code	ÜRÜN RESMİ Product Image	ÜRÜN AÇIKLAMASI Product Description	ADET Piece
BIO-2201		Polyemide Kılavuz Malzemesi Polyemide Guide Material	2
BIO-2202		Ön Kayış Çekme Aparatı 1 Front Belt Puller 1	2
BIO-2203		Ön Kayış Çekme Aparatı 2 Front Belt Puller 2	2
BIO-2204		Ön Kayış Çekme Aparatı 3 Front Belt Puller 3	2
BIO-2205		Ön Kayış Çekme Aparatı Sol Front Belt Puller Left	1
BIO-2206		Ön Kayış Çekme Aparatı Sağ Front Belt Puller Right	1
BIO-2207		Ön Kayış Çekme Aparatı 5 Front Belt Puller 5	2
BIO-2208		Ön Kayış Çekme Aparatı 6 Front Belt Puller 6	2
BIO-2207		M5X12 İnbus Civata M5X12 Inbus Bolt	14
BIO-2209		M6X25 İnbus Civata M6X20 Inbus Bolt	4

BIO-2100 Ön Gergi Takım Seti

BIO-2100 Front Tensionet Kit

BIO-2101		Ön Gerdirme Sacı Prestressing Sheet	2
BIO-2102		Ön Gerdirme Polyemide Teker Pre-Tensioning Polyemide Wheel	2
BIO-2004		Rulman Roller	4
BIO-2105		M6X100 AKV Civata M6X100 AKV Bolt	4
BIO-2103		10'luk Mil Segmani 10 Shaft Ring	4
BIO-2104		Pim Otomat Pin Automatic	2

BIO-2300 Piston Takım Seti

BIO-2300 Piston Kit





ÜRÜN KODU Product Code	ÜRÜN RESMİ Product Image	ÜRÜN AÇIKLAMASI Product Description	ADET Piece
BIO-2301		Piston Motor Piston Engine	2
BIO-2302		Lineer Motor Alt Kasa Linear Motor Bottom Case	2
BIO-2303		Lineer Motor Makası Linear Motor Scissors	4
BIO-2304		Lineer Motor Üst ve Alt Pimi Linear Motor Upper & Bottom Pim	4
BIO-2305		Motor Makas Şase Sacı Pimi Motor Scissor Frame Sheet Pim	2
BIO-2306		Motor Makas Ve (C) Kanal Pimi Motor Scissors And (C) Channel Pin	2
BIO-2510		Motor Ve (C) Kanal Sabitleme Lokması Engine And (C) Channel Fixing Socket	2
BIO-2506		M6X12 Setskur M6X12 Setskur	4
BIO-2307		8' lik Ay Segmanı (Kaplmalı) Eighth Moon Ring (Coated)	8
BIO-2308		10' luk Ay Segmanı (Kaplmalı) Ten Moon Ring (Coated)	8
BIO-2508		4.8X19 YSB Bombe Baş Akıllı Vida 4.8X19 YSB Bomb Head Smart Screw	50

BIO-2400 105° Açılım Takım Seti
BIO-2400 105° Opening Tool Set

ÜRÜN KODU Product Code	ÜRÜN RESMİ Product Image	ÜRÜN AÇIKLAMASI Product Description	ADET Piece
BIO-2401		Panel (C) Kanalı Ön Çekme Masfali Panel (C) Channel Front Drawing Joint	1
BIO-2402		Panel (C) Kanalı Ön Çekme Aparatı Panel (C) Channel Front Towing Apparatus	1
BIO-2512		10X2 mm Plastik Pul 10X2 mm Plastic Washer	8
BIO-2403		Kilit Lokması Küçük Lock Socket Small	1
BIO-2510		Motor ve (C) Kanal Sabitleme Lokması Engine & (C) Channel Fixing Socket	1
BIO-2404		Kilit Lokması Büyük Lock Socket Large	1
BIO-2405		Çelik Yay Steel Spring	1
BIO-2209		M6X25 İnbus Civata M6X25 İnbus Civata	1
BIO-2511		Mafsal Pimi Joint Pim	4
BIO-2306		Motor Makas Ve (C) Kanal Pimi Engine Scissors & (C) Channel Pim	1
BIO-2506		M6X12 Setskur M6X12 Setskur	9

Aksesuarlar / Accesories

ÜRÜN KODU Product Code	ÜRÜN RESMİ Product Image	ÜRÜN AÇIKLAMASI Product Description	ADET Piece
BIO-2500		Hareketli Lamel Kapağı Movable Lamella Cover	
BIO-2501		Arka Sabit Lamel Kapağı Rear Fixed Lamella Cover	
BIO-2502		Lamel Alt Teker Pimi Lamella Bottom Wheel Pin	
BIO-2503		Lamel Üst Teker Pimi Lamella Upper Wheel Pin	
BIO-2504		Rulmanlı Teker Bearing Wheel	
BIO-2505		Çelik Tel Mafsalı Steel Wire Joint	
BIO-2506		M6X12 Setskur M6X12 Setskur	
BIO-2507		M6X12 İnbus Civata M6X12 İnbus Bolt	
BIO-2508		4.8X19 YSB Bombe Baş Akıllı Vida 4.8X19 YSB Bomb Head Smart Screw	
BIO-2509		C Mafsal Lazeri C Joint Laser	
BIO-2510		Motor Ve (C) Kanal Sabitleme Lokması Engine And (C) Channel Fixing Socket	
BIO-2511		Mafsal Pimi Joint Pim	

ÜRÜN KODU Product Code	ÜRÜN RESMİ Product Image	ÜRÜN AÇIKLAMASI Product Description	ADET Piece
BIO-2512		10X2 mm Plastik Pul 10X2 mm Plastic Washer	
BIO-2513		Ray Sabitleme Lazeri Rail Fixing Laser	
BIO-2514		Arka Panel Sabitleme Parçası Rear Panel Fixing Piece	
BIO-2515		Köşe Ayak Üst Bağlantı Parçası Corner Column Top Connector	
BIO-2515-1		Köşe Ayak Üst Bağlantı Kapama Sacı Corner Column Upper Connection Closure Sheet	
BIO-2516		Ayak Alt Köşe Bağlantı Parçası Column Bottom Corner Connector	
BIO-2517		Oluk 90° (L) Birleştirme Parçası Gutter 90° (L) Combining Piece	
BIO-2518		Orta Ayak Üst Bağlantı Parçası Mid-Column Upper Bracket	
BIO-2518-1		Orta Ayak Üst Bağlantı Kapama Sacı Middle Column Upper Connection Closure Plate	
BIO-2519		Orta Ayak Alt Bağlantı Parçası Mid-Column Bottom Bracket	
BIO-2520		Ayaksız Duvar Köşe Bağlantı Parçası Columnless Wall Corner Bracket	
BIO-2520-1		Ayaksız Duvar Köşe Bağlantı Sacı 1 mm Deliksiz Columnless Wall Corner Connection Plate 1 mm Without Hole	

ÜRÜN KODU Product Code	ÜRÜN RESMİ Product Image	ÜRÜN AÇIKLAMASI Product Description	ADET Pieces
BIO-2520-2		Ayaksız Duvar Köşe Bağlantı Sacı 1 mm L Columnless Wall Corner Connection Plate 1 mm L	
BIO-2520-3		Ayaksız Duvar Köşe Bağlantı Sacı 1 mm R Columnless Wall Corner Connection Plate 1 mm R	
BIO-2520-4		Ayaksız Duvar Köşe Bağlantı L90. Columnless Wall Corner Connection 90°	
BIO-2521		Ayaksız Orta Duvar Bağlantı Parçası L Columnless Middle Wall Bracket L	
BIO-2521-1		Ayaksız Orta Duvar Bağlantı Parçası R Columnless Middle Wall Bracket R	
BIO-2521-2		Ayaksız Orta Duvar Bağlantı Kapama Sacı Columnless Middle Wall Connection Closure Plate	
BIO-2521-3		Ayaksız Orta Duvar Bağlantı Sacı T Columnless Middle Wall Connection Plate T	
BIO-2522		Lamel Master Sacı Gauge Plate Of Lamella	
BIO-2523		M8X40 Tam Diş AKV Civata M8x40 Full Thread AKV Bolt	
BIO-2524		T10x20 Triger Kayış T10x20 Timing Belt	
BIO-2525		5 mm İzoleli Çelik Halat 5 mm Insulated Steel Rope	
BIO-2526		Lamel Contası Epdm Lamella Gasket Epdm	

ÜRÜN KODU Product Code	ÜRÜN RESMİ Product Image	ÜRÜN AÇIKLAMASI Product Description	ADET Piece
BIO-2527		Oluk Contası Epdm Groove Gasket Epdm	
BIO-2528		Bioklimatik Kontrol Panosu (Sensör+Led) Bioclimatic Control Panel (Sensor+Led)	
BIO-2529		İzoleli Led Isolated Led	
BIO-2530		Difüzör Kapağı Diffuser Cover	
L80/11 CM04		Becker R80 M04 Alıcısız Motor Becker Engine	
L120/11 CM04		Becker R120 M04 Alıcısız Motor Becker Engine	
GYTN-2000		70' lik Sekizgen Boru Sac Octagonal Aluminum Tubing - Sheet Metal	

Sistem Profil Konumları System Profile Locations

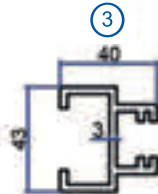
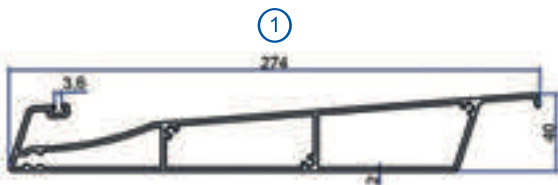

7

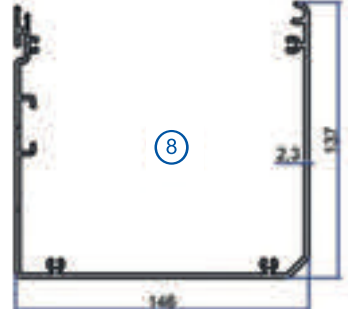
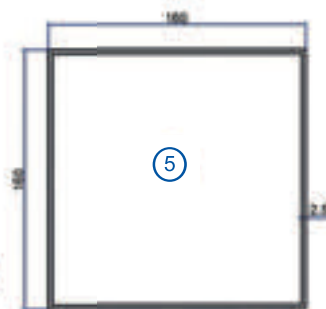
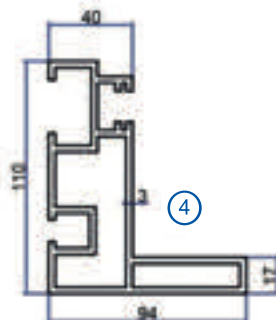
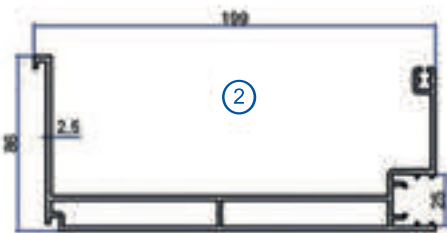

Sistem Profil Konumları System Profile Locations

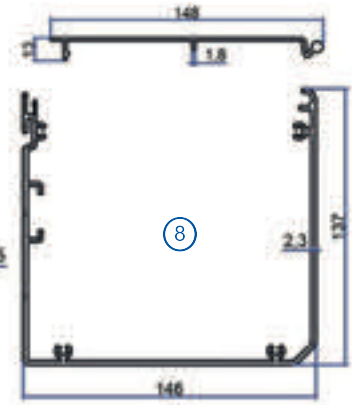
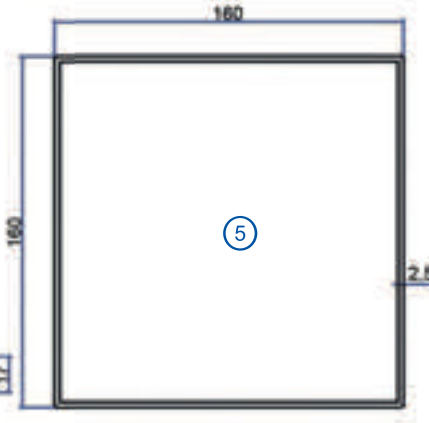
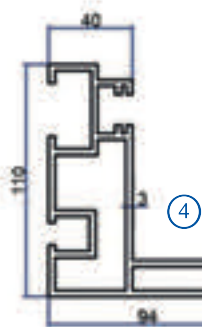
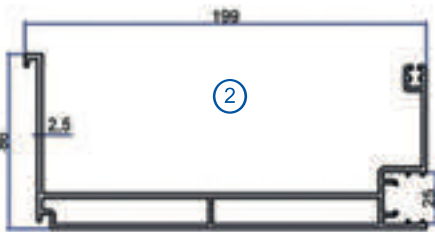
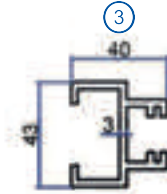
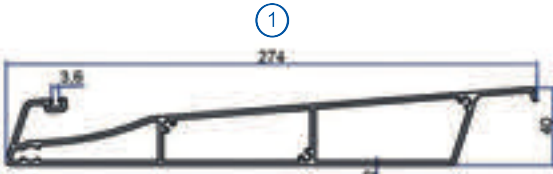
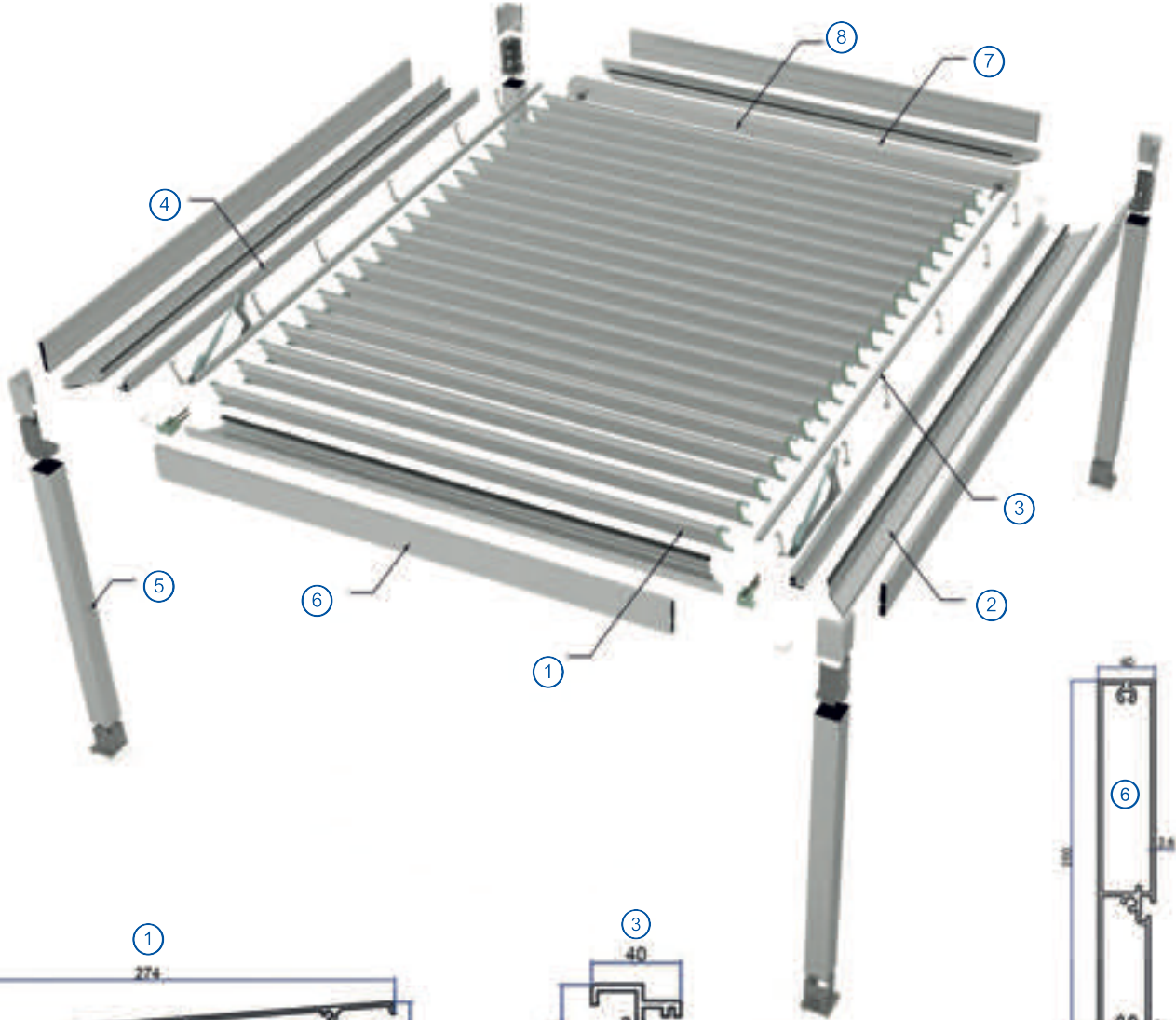

Köşe Bağlantı Sistemleri Corner Connection System



Sistem Profil Konumları System Profile Locations

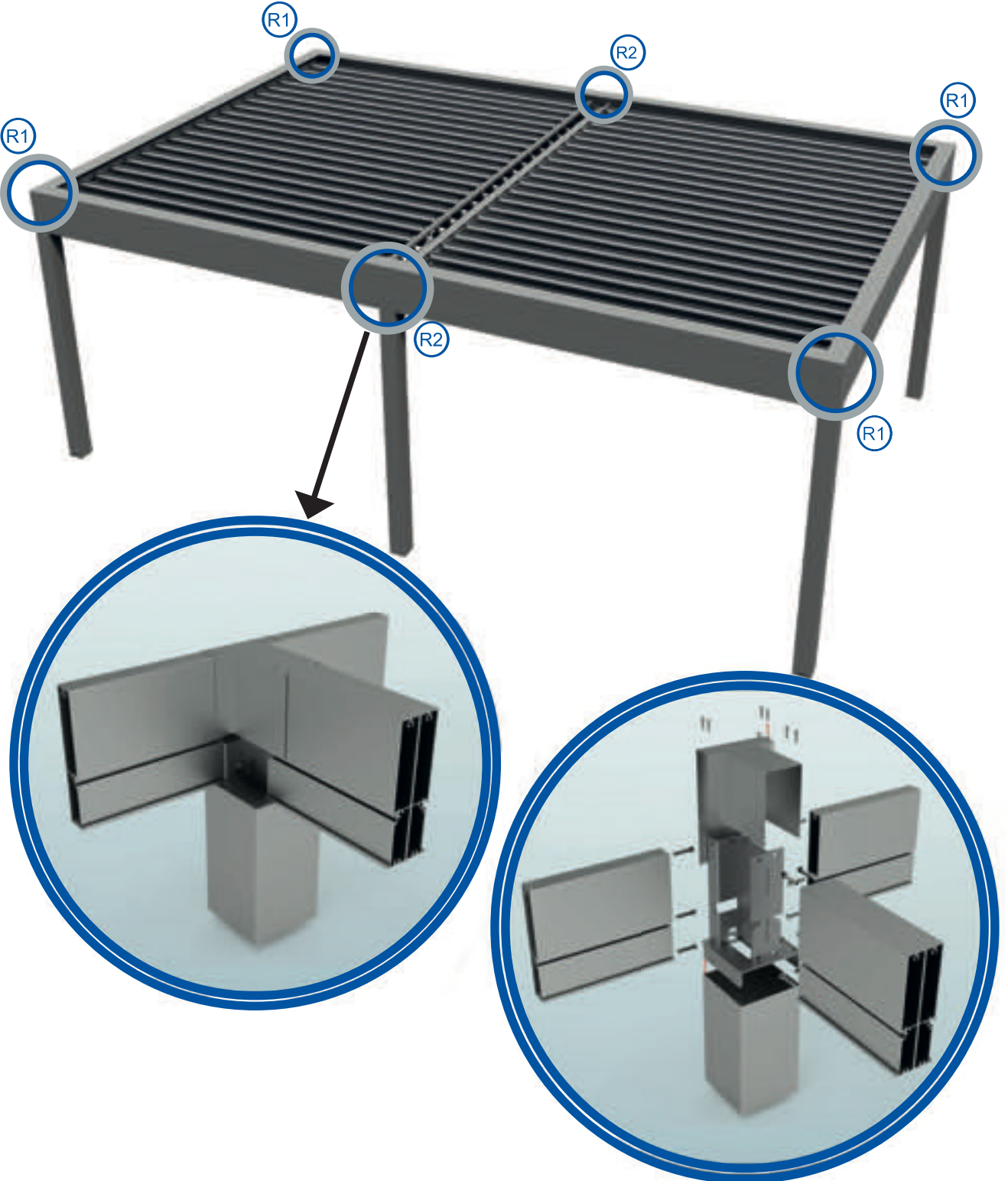

Köşe Bağlantı Sistemleri Corner Connection System

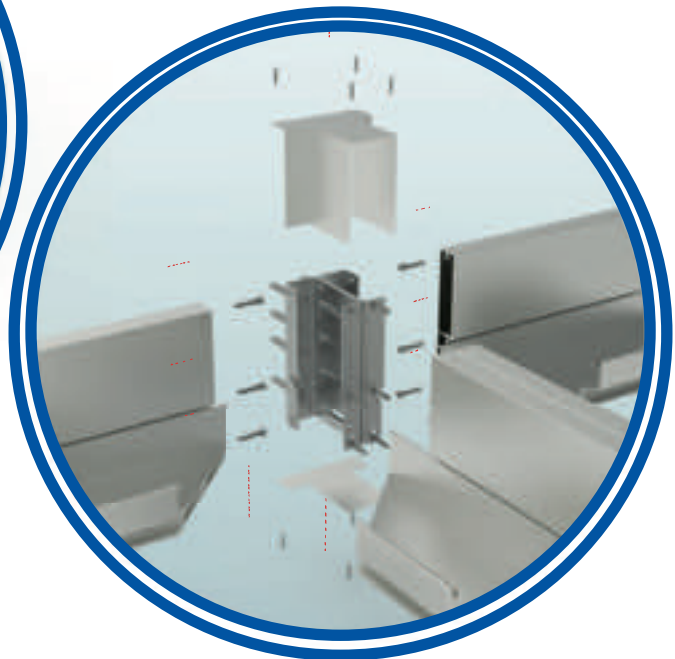
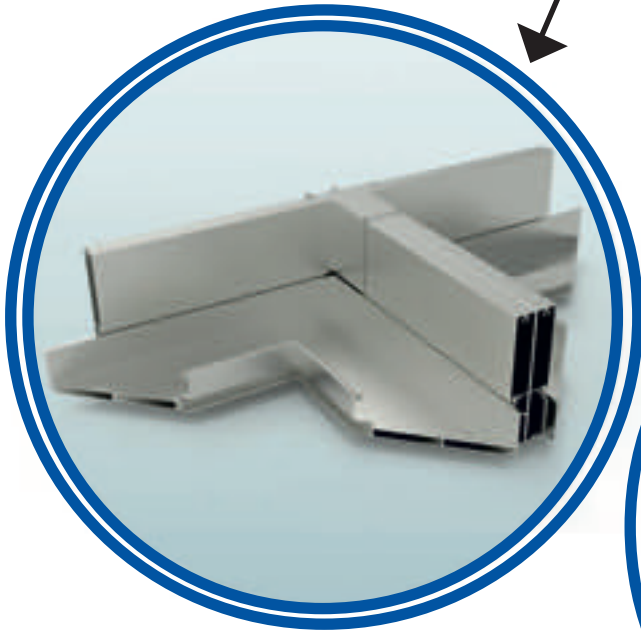

Köşe Bağlantı Sistemleri Corner Connection System

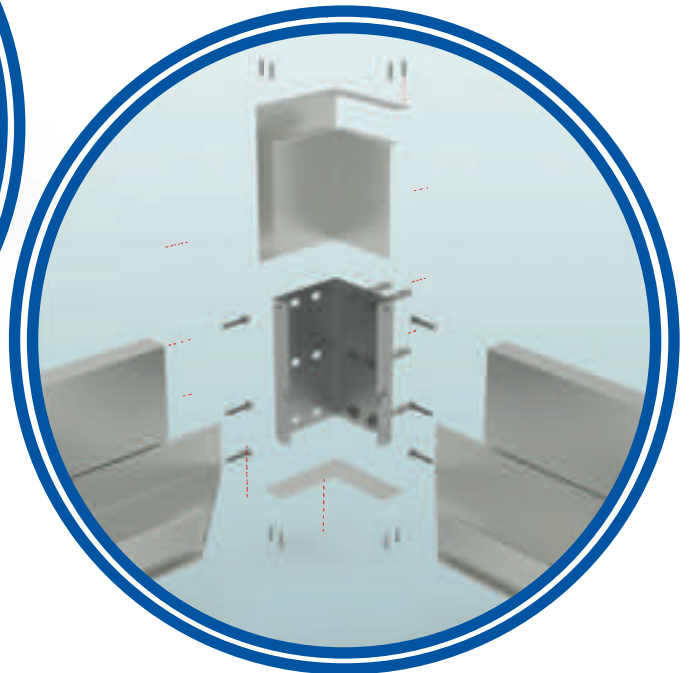
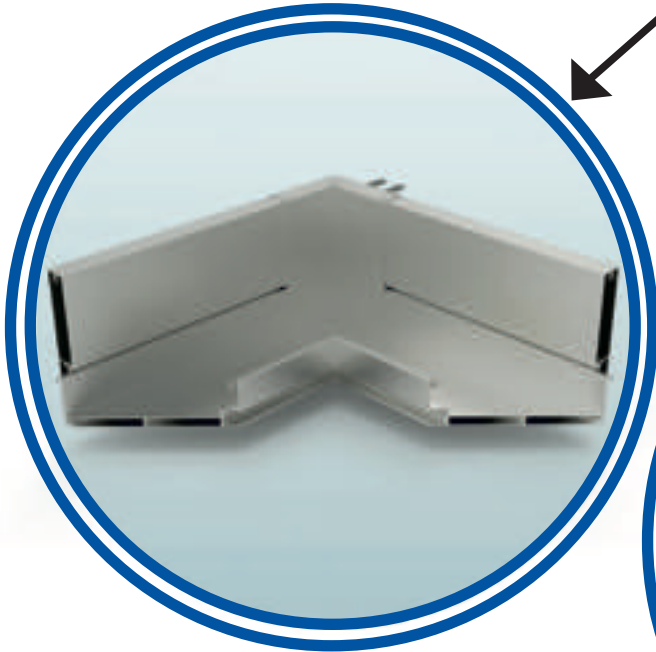

Montaj Şeması / Assembly Diagram

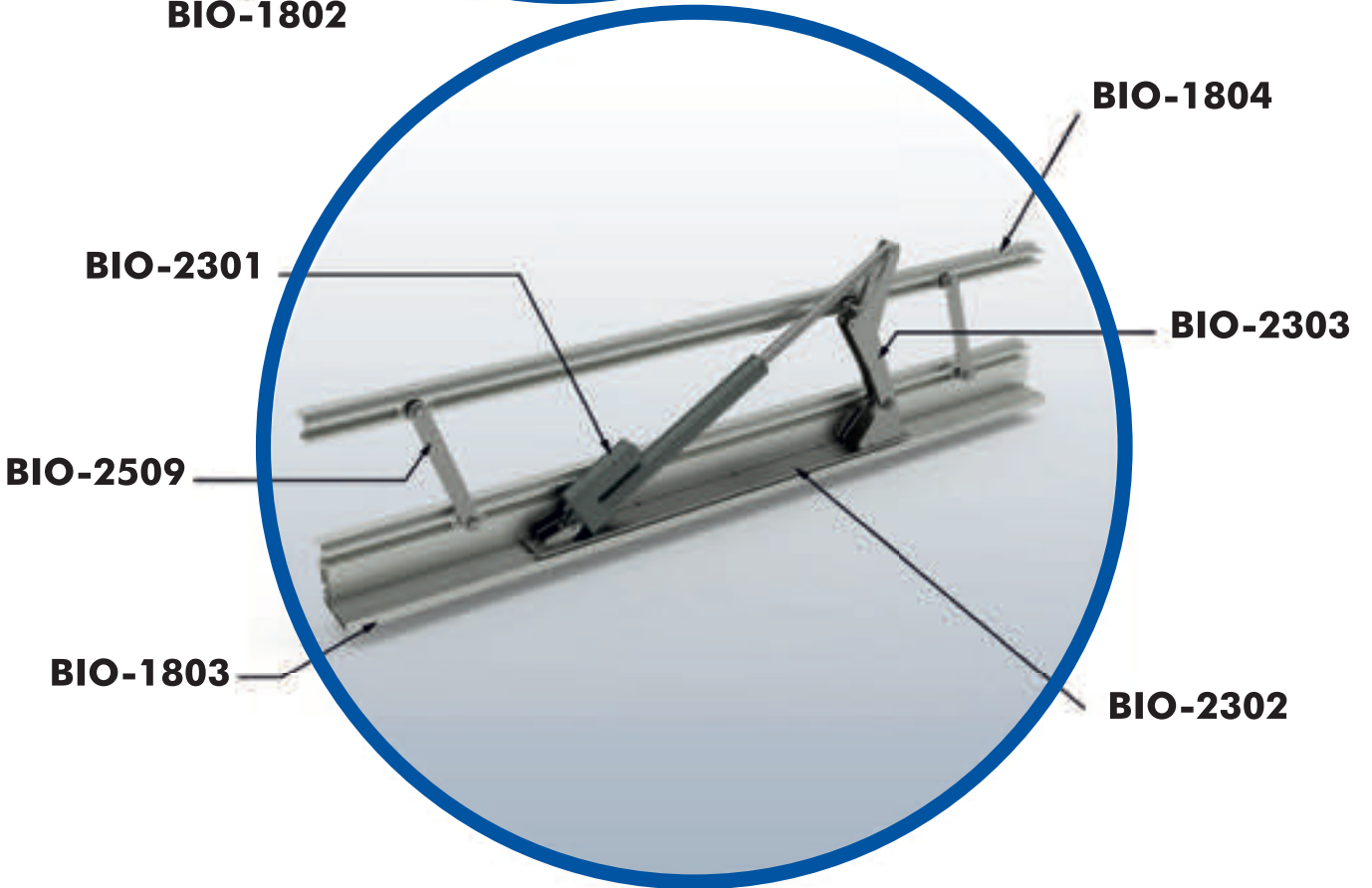
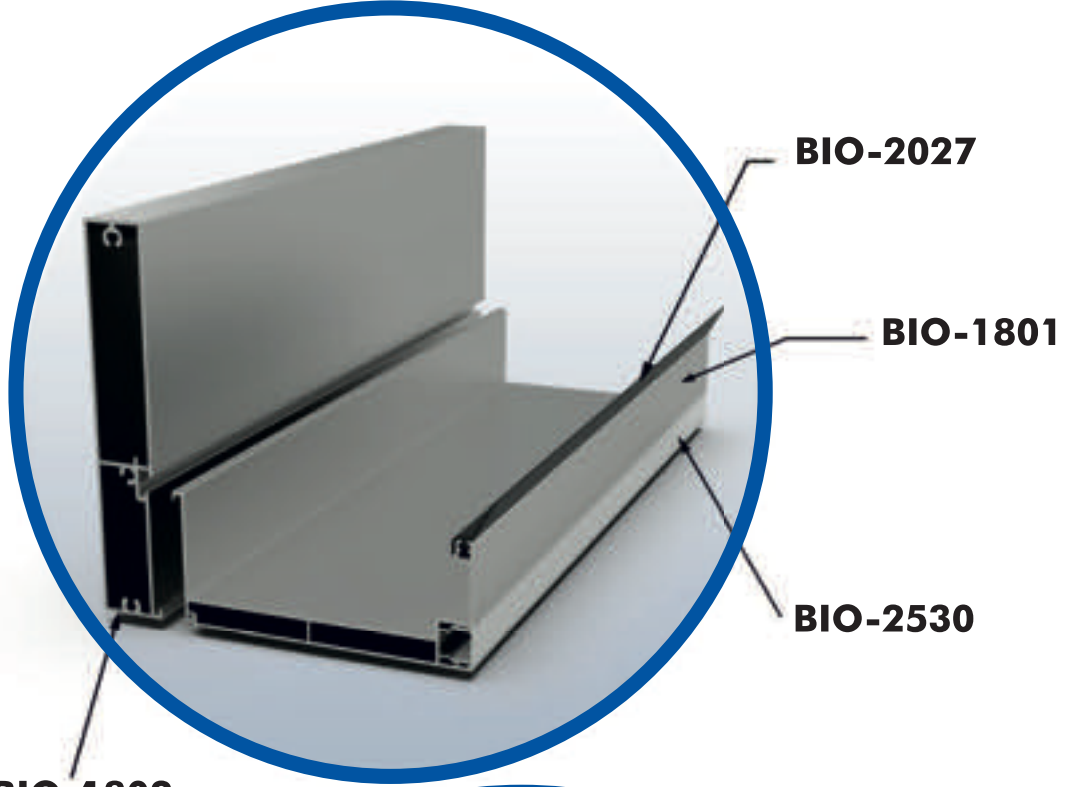

Ön Kilit Montajı Front Lock Assembly

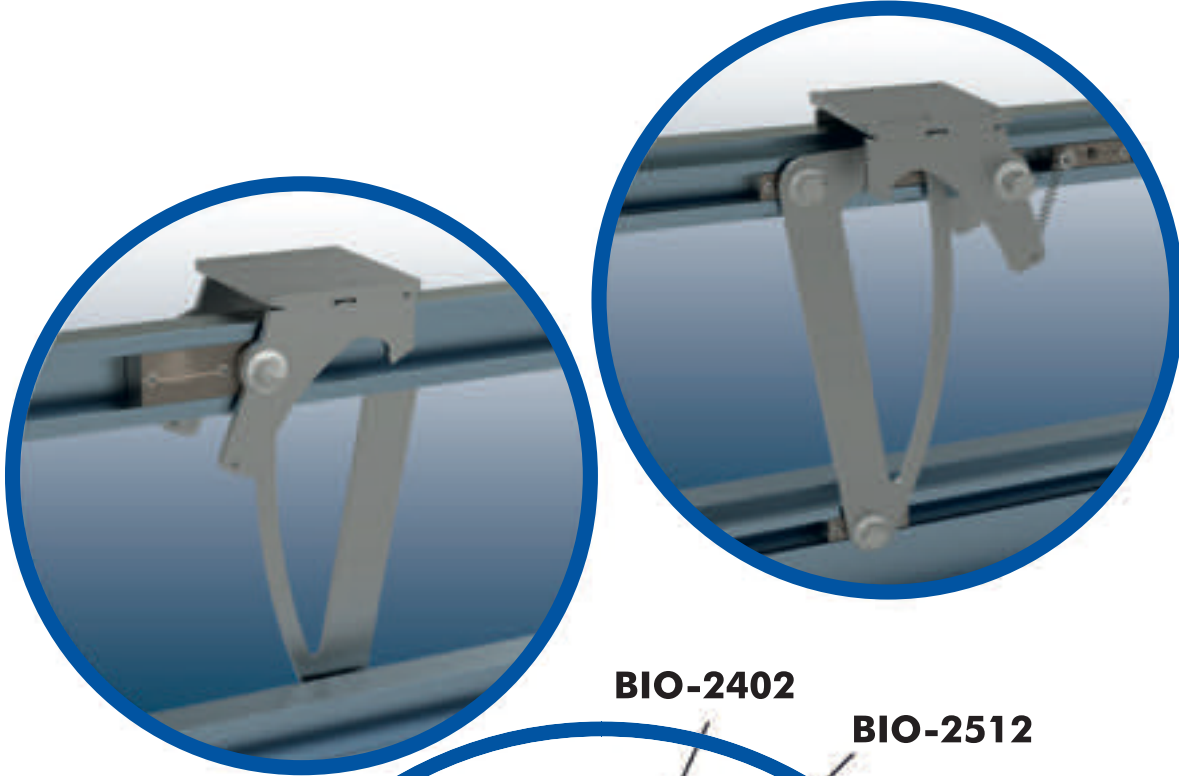

BIO-2402

BIO-2512

BIO-2511

BIO-2511

BIO-1804

BIO-2401

BIO-2510

BIO-2306

BIO-2506

BIO-2209

BIO-2405

BIO-1803

Lamel Montajı Lamel Installation

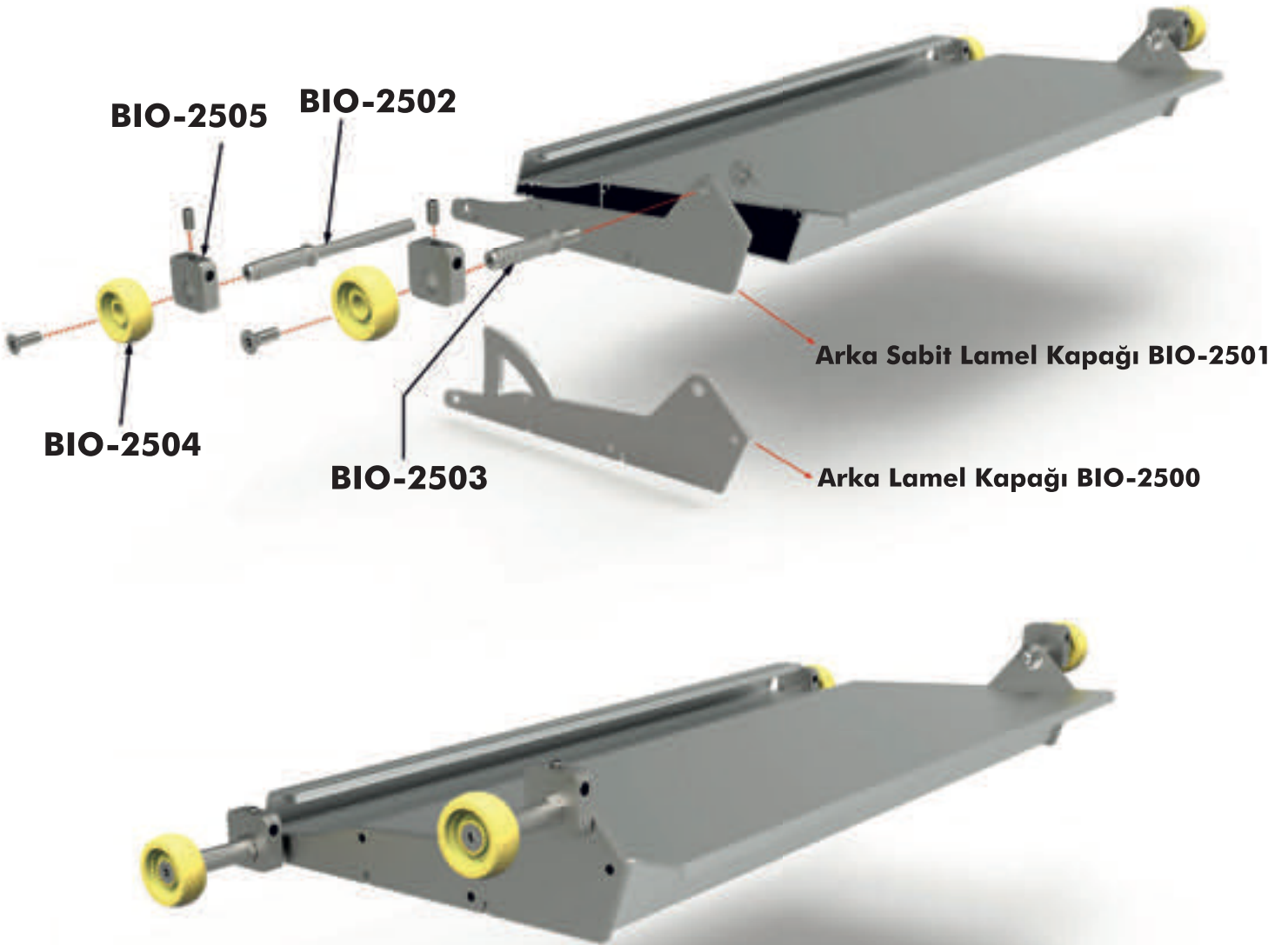

Motor Kutusu Montajı Engine Box Installation

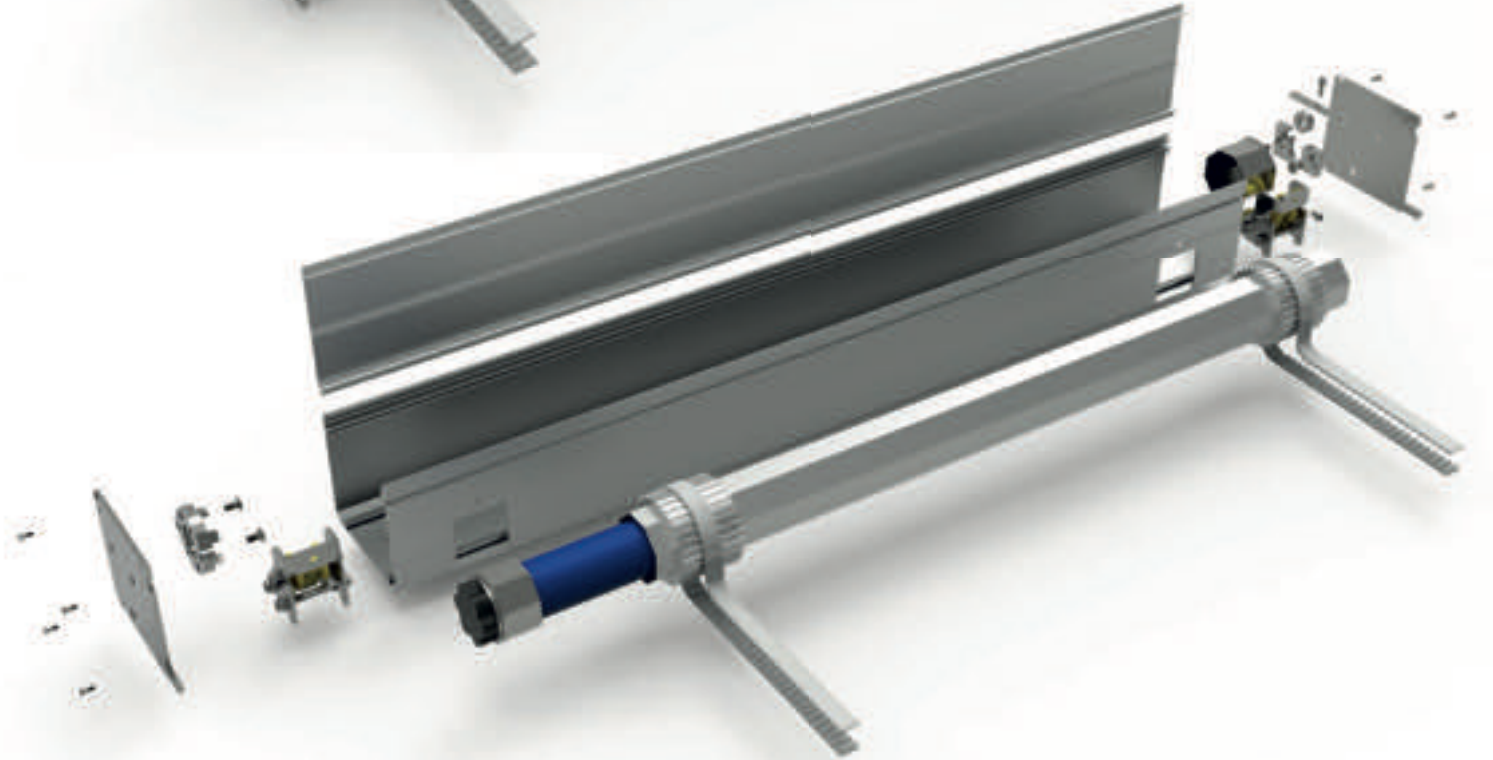

Motor Kutusu Montajı Engine Box Installation

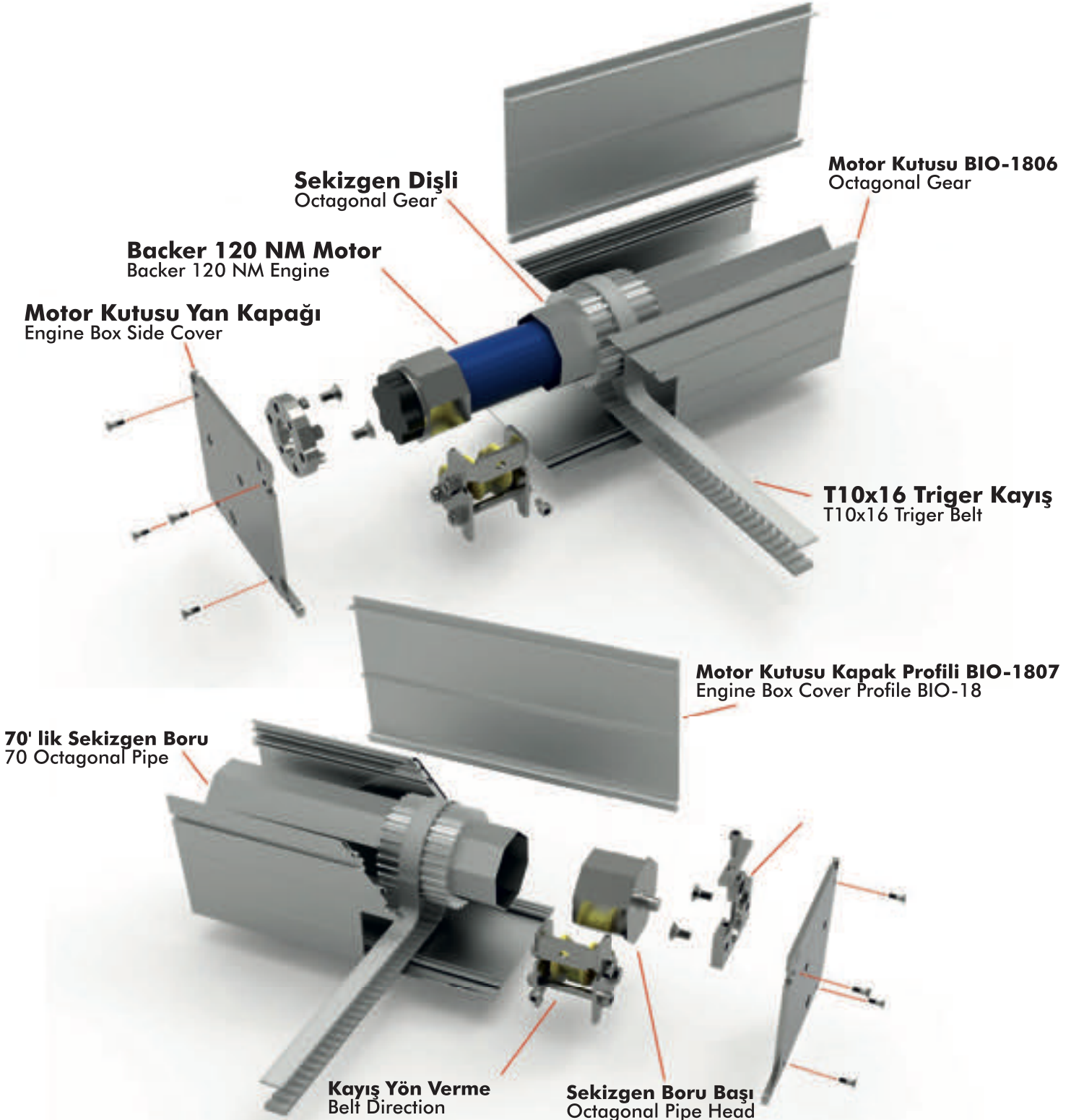

Motor Kutusu Kertme İşlemi Engine Box Notching Operation

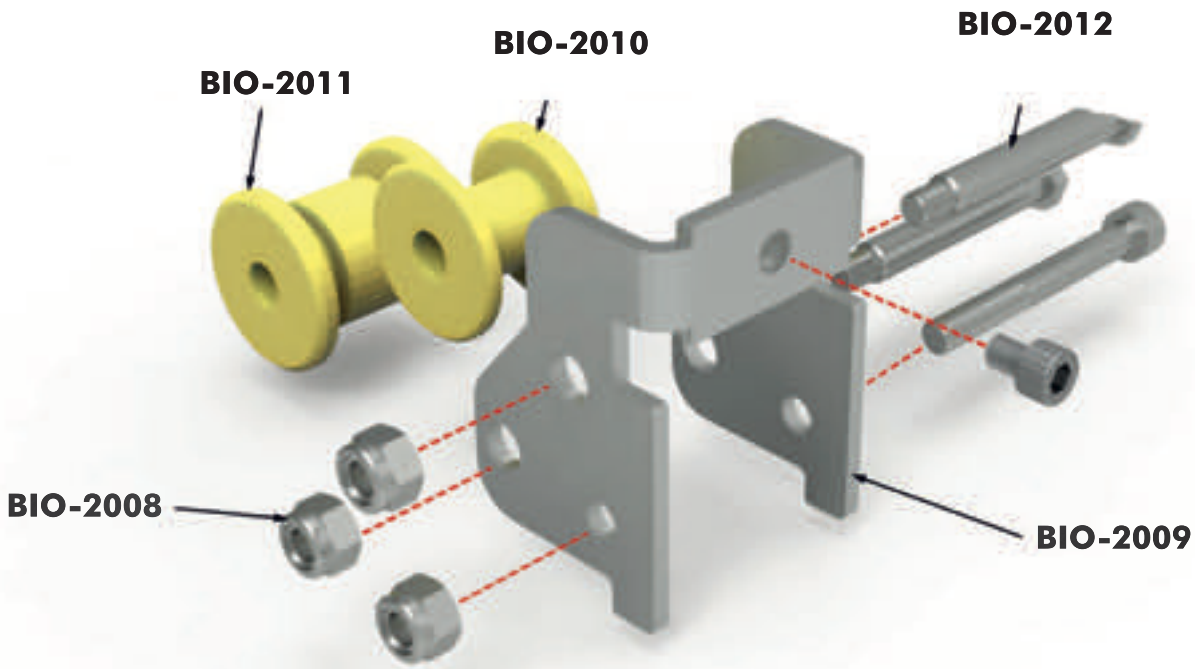

Ön Çekici Montajı Front Tractor Installation

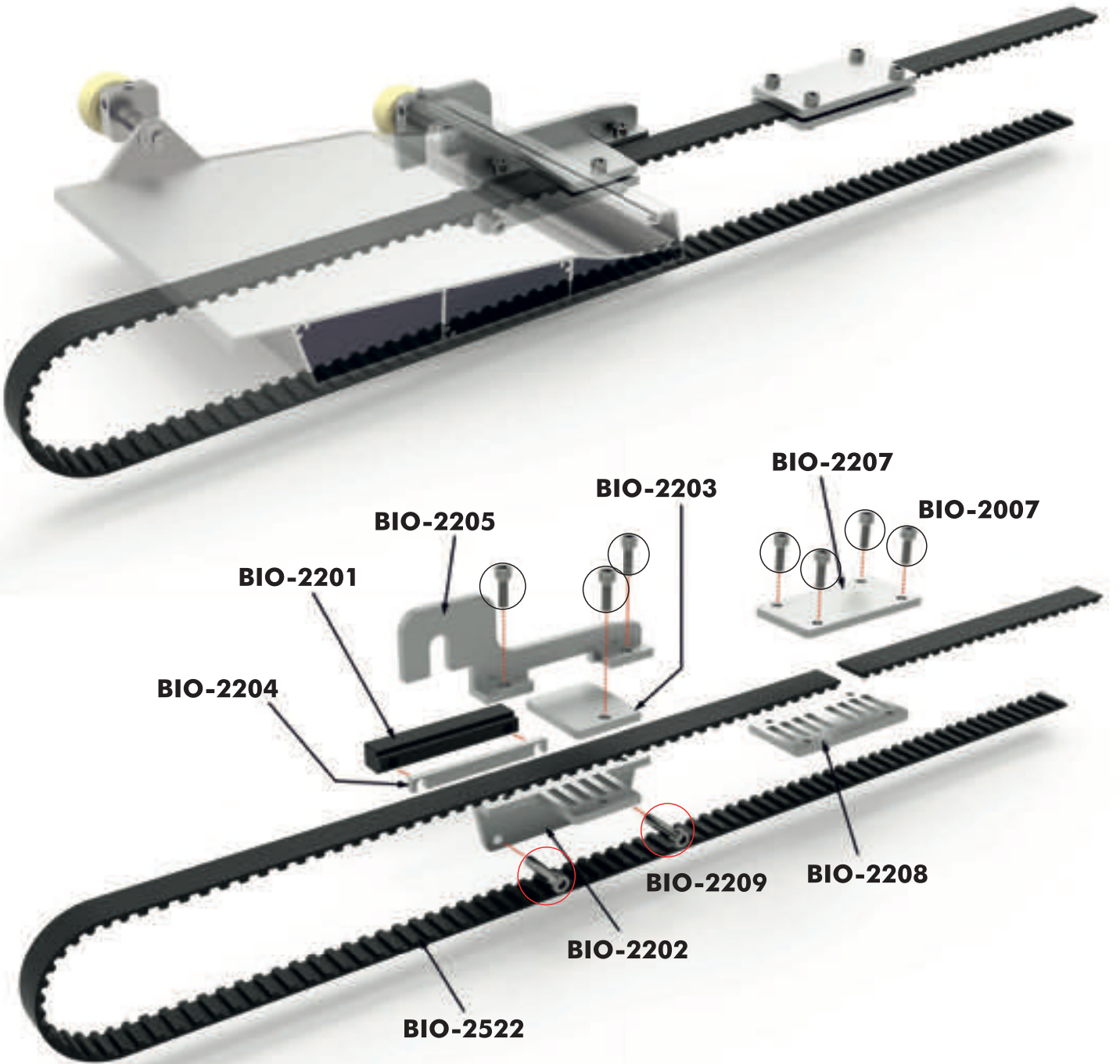

Ön Gergi Mekanizması Pre-tensioner Mechanism

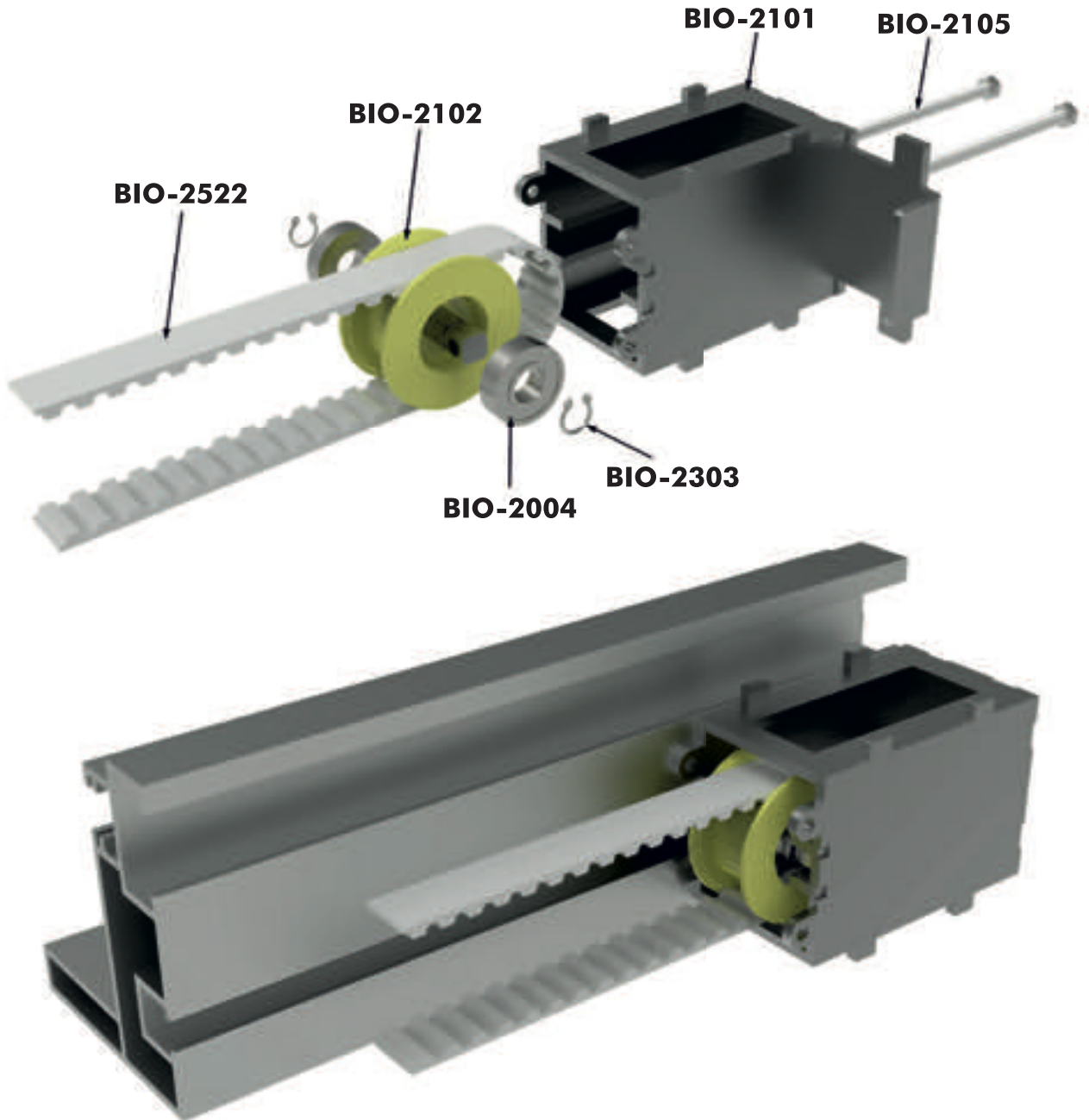

Ayak Kertme İşlemi Food Notching Process



Ayak Alt Köşe Bağlantı
Foot Bottom Corner Connection
BIO-2516



Ayak Alt Köşe Bağlantı
Foot Bottom Corner Connection
BIO-2519

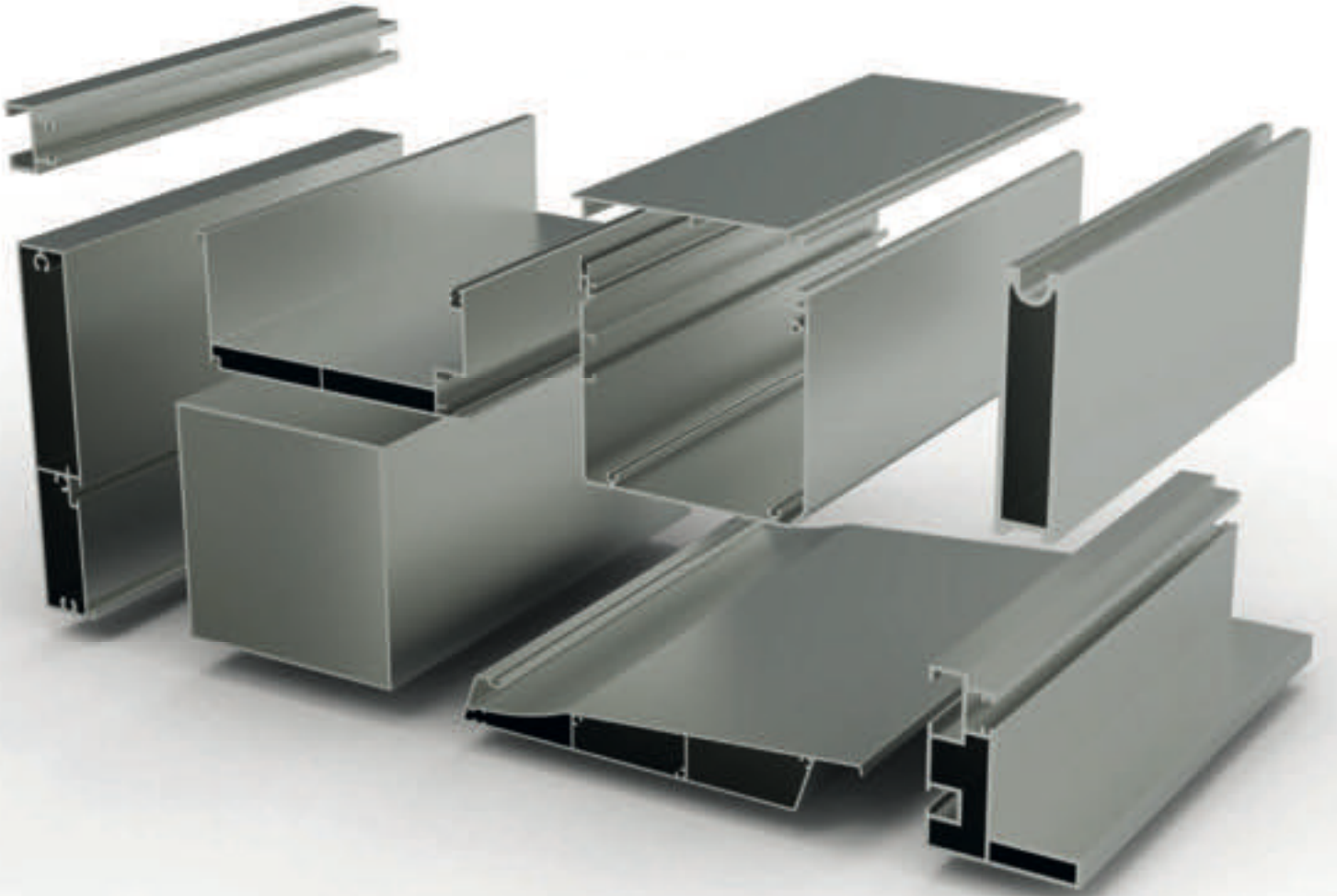



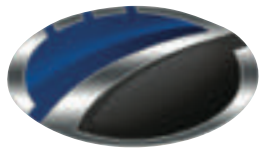

ÖZGÜLLER
ALUMINIUM SYSTEMS



ÖZGÜLLER
ALUMINIUM SYSTEMS



0266 392 1258



ozgulleraluminyum



ozgulleraluminyum

ozgulleraluminyum.com.tr