



ÖZGÜLLER
ALUMINIUM SYSTEMS



Giyotin Cam Balkon / Guillotine Glass Balcony



GIYOTIN CAM
"Temizlenebilir Akıllı Cam Sistemleri"



GIYOTIN CAM
HAREKETLİ KÜPEŞTE SİSTEMİ





Temizlenebilir Giyotin Cam Isıcamlı & 8 mm
Cleanable Guillotine Glass (Double Glass & 8 mm)



Giyotin Cam Balkon Sistemi, dikey olarak hareket eden kumandalı bir sistemdir. Özel tasarım olan paslanmaz profiller ve çelik taşıyıcılarla kurulan sistem, %100 güvenli kullanım sağlar.

Kurulduğu mekanlara kesintisiz panoramik bir manzara sağlayan bu sistem uzaktan kumanda aracılığıyla kontrol edilmektedir. Sistemin ısıcamlı seçeneği mevcuttur.

Patentli tasarıma sahip profil yapısı ve çelik makası ile camların dış kısımları kolayca temizlenebilir.

Guillotine Glass Balcony System, vertically it is a remote controlled system. Specially designed stainless profiles and The system installed with steel carriers provides 100% safe use.

This system, which provides an uninterrupted panoramic view to the places where it is installed, is controlled by a remote control. The system has an insulating glass option.

With its patented design profile structure and steel scissors, the outer parts of the glasses can be easily cleaned.

Giyotin Cam / Guillotine Glass

Temizlenebilir Giyotin Cam Isıcamlı & 8 mm
Cleanable Guillotine Glass (Double Glass & 8 mm)

Profiller Profiles

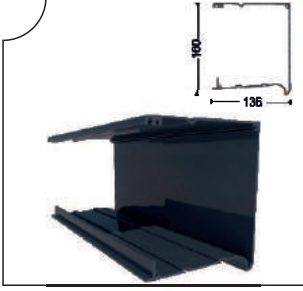

GYTN-1701 Üst Kutu Antrasit Gri
Upper Box Anthracite Gray

Ağırlık/Weight
3.49 kg/m

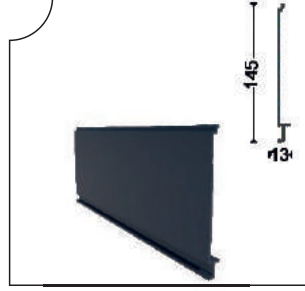

GYTN-1702 Üst Kutu Ön Kapak
Upper Box Front Cover

Ağırlık/Weight
0.84 kg/m

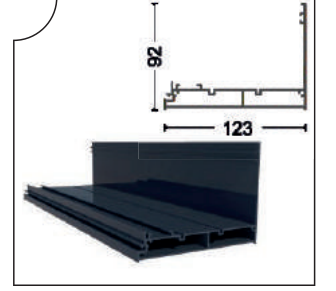

GYTN-1713 Yan Dikme
Side Profile

Ağırlık/Weight
1.844 kg/m

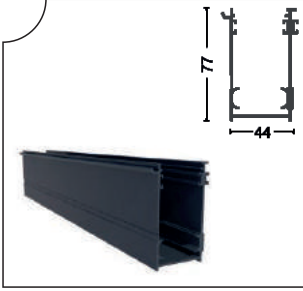

GYTN-1714 "U" Yan Dikme
"U" Side Profile

Ağırlık/Weight
1.362 kg/m

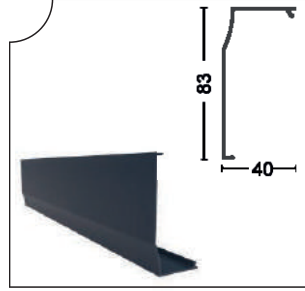

GYTN-1715 "L" Kapak
"L" Cover

Ağırlık/Weight
0.562 kg/m

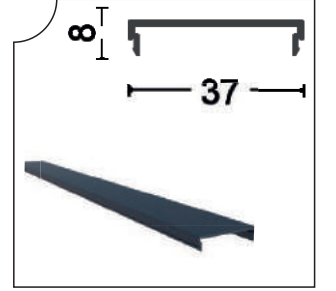

GYTN-1716 Yan Dikme Kapak
Side Stand Cover

Ağırlık/Weight
0.19 kg/m

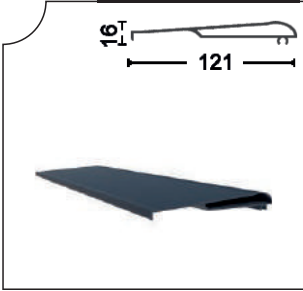

GYTN-1717 Hareketli Küpeşte
Movable Handrail

Ağırlık/Weight
0.92 kg/m

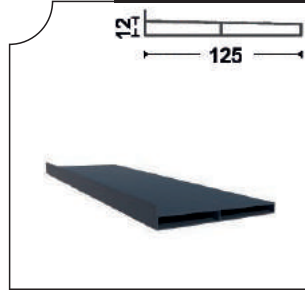

GYTN-1718 Alt Kasa
Bottom Frame

Ağırlık/Weight
1.03 kg/m

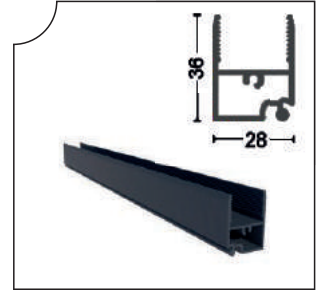

GYTN-1719 Alt-Üst Isıcamlı Baza
Bottom-Top Insulating Glass Base

Ağırlık/Weight
0.63 kg/m

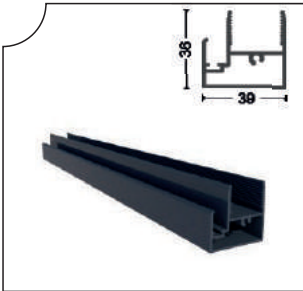

GYTN-1720 Çekme Baza Isıcamlı
Pull Base With Double Glazing

Ağırlık/Weight
0.727 kg/m

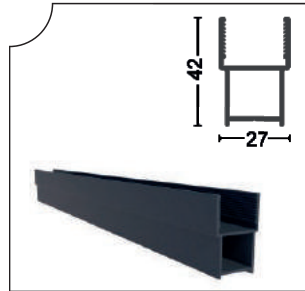

GYTN-1721 Dikey Baza Isıcamlı
Profile Of Insulated Vertical

Ağırlık/Weight
0.562 kg/m

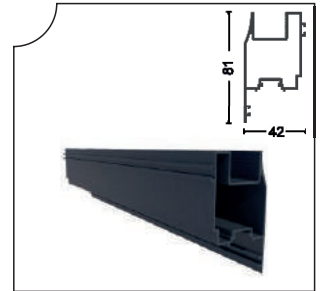

GYTN-1722 Ağır Kanat Isıcamlı
Profile Of Insulated Opens

Ağırlık/Weight
1.044 kg/m



Profiller Profiles

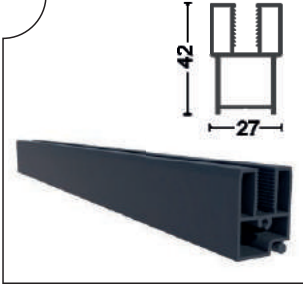

GYTN-1723 Alt-Üst Baza 8 mm
Lower-Upper Base 8 mm
Ağırlık/Weight
0.816 kg/m

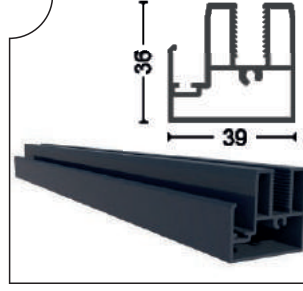

GYTN-1724 Çekme Baza 8 mm
Pull Base 8 mm
Ağırlık/Weight
0.908 kg/m

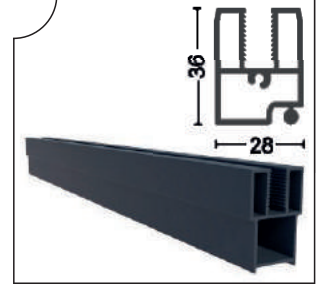

GYTN-1725 Dikey Baza 8 mm
Vertical Base
Ağırlık/Weight
0.706 kg/m

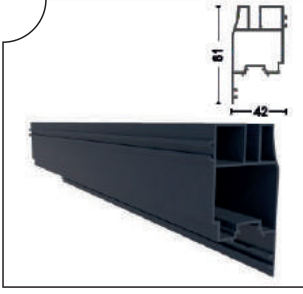

GYTN-1726 Ağırlır Kanat 8 mm
Profile Of Opens 8 mm
Ağırlık/Weight
1.14 kg/m

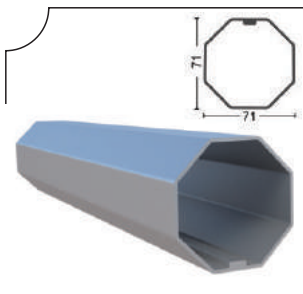

GYTN-2000 70'lik Sekizgen Boru
Octogonal Aluminum Tubing



Temizlenebilir Giyotin Cam Isıcamlı & 8 mm
Cleanable Guillotine Glass (Double Glass & 8 mm)

Aksesuarlar Accessories



GYTN-2018 Aksesuar Kayışlı Temizlenebilir
Accessory Belt Cleanable



GYTN-2019 Aksesuar Zincirli Temizlenebilir
Accessory Chain Cleanable



GYTN-2005 Çelik Zincir
Steel Chain



GYTN-2004 Çelik Kayış
Steel Strap

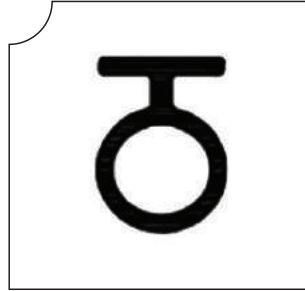

GYTN-2003 Balon Conta
Rubber Seal



GYTN-2015 İspanyolet 28 cm
Espagnolette 28 cm

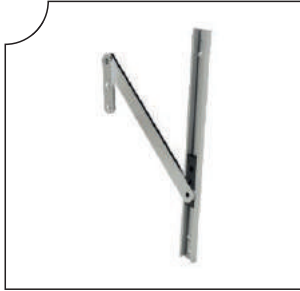

GYTN-2016 Çelik Makas
Steel Truss of Façade



GYTN-2017 Çelik Makas
Steel Truss of Façade With Roller



KLFTL-1004 67x1000 Kıl Fıfıl
Brush Seal 67x1000



ISICM31-2008 İspanyol Siyah Kol
Espagnolette Handle Black



GYTN-2014 Gömme İspanyolet - Siyah
Recessed Espagnolette Sleeve - Black

1-ISICM31-2009 Antrasit Gri /Anthracite Gray
2-ISICM31-2010 Eloksal/Anodized

1-GYTN-2013 Antrasit Gri/Anthracite Gray
2-GYTN-2012 Eloksal/Anodized

Aksesuarlar Accessories



2120-130-103-0 Becker L 120 NM (PSF+) Motor
Becker Guillotine Engine



2080-130-130-0 Becker L 80 NM (PSF+) Motor
Becker Guillotine Engine



4034-000-201-0 Becker 1 Kanallı Kumanda
Becker 1 Connection Remote Control



4034-000-202-0 Becker 5 Kanallı Kumanda
Becker 5 Connection Remote Control



4034-000-203-0 Becker 10 Kanallı Kumanda
Becker 10 Connection Remote Control



MOSEL70RE120 Mosel 70-120 Elk. Alicılı Motor
Mosel Guillotine Engine



MOSEL70R120 Mosel 70-120 Alicılı Motor
Mosel Guillotine Engine



MOSEL70RE140 Mosel 70-140 Elk. Alicılı Motor
Mosel Guillotine Engine



MOSEL70R140 Mosel 70-140 Elk. Alicılı Motor
Mosel Guillotine Engine



RCOTMDC104 Mosel 1 Kanallı Kumanda
Mosel 1 Connection Remote Control



RCOTMDC105 Mosel 5 Kanallı Kumanda
Mosel 5 Connection Remote Control

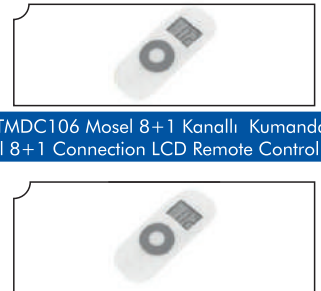

RCOTMDC106 Mosel 8+1 Kanallı Kumanda
Mosel 8+1 Connection LCD Remote Control



RCOTMDC107 Mosel 14+1 Kanallı Kumanda
Mosel 14+1 Connection LCD Remote Control







Klasik Giyotin Cam Isıcamlı & 8 mm
Classic Guillotine Glass (Double Glass & 8 mm)



Giyotin Cam Balkon Sistemi, dikey olarak hareket eden kumandalı bir sistemdir. Özel tasarım olan paslanmaz profiller ve çelik taşıyıcılarla kurulan sistem, %100 güvenli kullanım sağlar.

Kurulduğu mekanlara kesintisiz panoramik bir manzara sağlayan bu sistem uzaktan kumanda aracılığıyla kontrol edilmektedir. Sistemin ısıcamlı seçeneği mevcuttur

Guillotine Glass Balcony System, vertically it is a remote controlled system. Specially designed stainless profiles and The system installed with steel carriers provides 100% safe use. This system, which provides an uninterrupted panoramic view to the places where it is installed, is controlled by a remote control. The system has an insulating glass option.

Giyotin Cam / Guillotine Glass

Klasik Giyotin Cam Isıcamlı & 8 mm
Classic Guillotine Glass (Double Glass & 8 mm)

Profiller Profiles

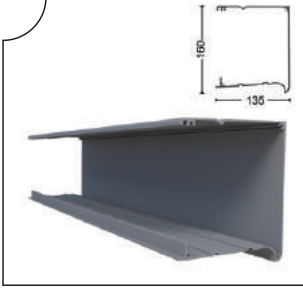

GYTN-1701 Üst Kutu Profili
Upper Box Profile

Ağırlık/Weight
3.49 kg/m

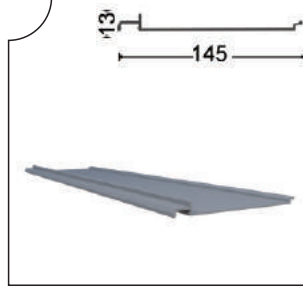

GYTN-1702 Üst Kutu Ön Kapağı
Upper Box Cover Profile

Ağırlık/Weight
0.84 kg/m

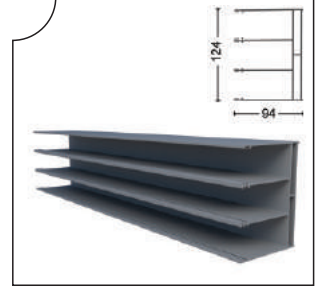

GYTN-1710 Yan Dikme Profili
Side Profile

Ağırlık/Weight
2.87 kg/m

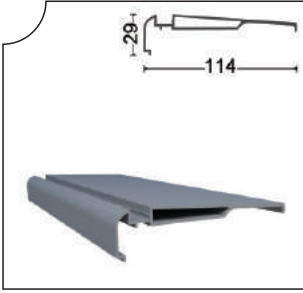

GYTN-1704 Küpeşte Profili
Railing Profile

Ağırlık/Weight
1.04 kg/m

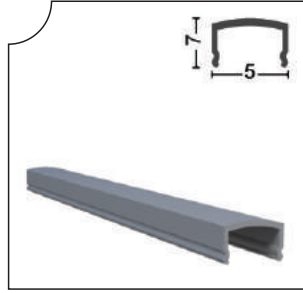

GYTN-1705 Küpeşte Çıtası Profili
Railing Slat Profile

Ağırlık/Weight
0.065 kg/m

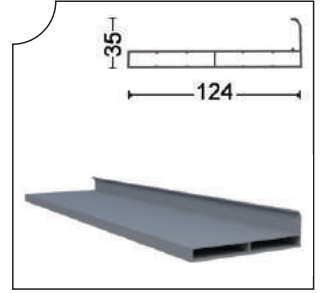

GYTN-1706 Alt Kasa Profili
Lower Fram Profile

Ağırlık/Weight
1.16 kg/m

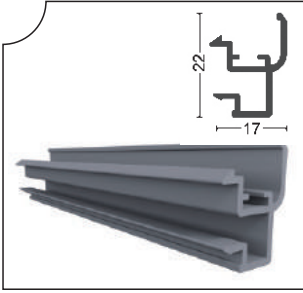

GYTN-1707 Çekme Çıtası Profili
Pull Bread Profile

Ağırlık/Weight
0.26 kg/m

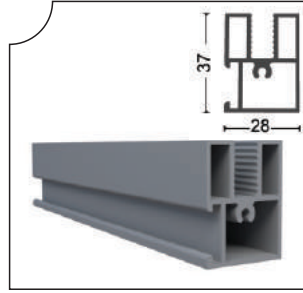

GYTN-1708 Baza 8 mm Profili
Aluminum Glass Profile

Ağırlık/Weight
0.802 kg/m

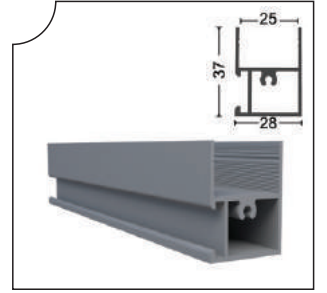

GYTN-1709 Baza Isıcam Profili
Aluminum Double Glass Profile

Ağırlık/Weight
0.60 kg/m

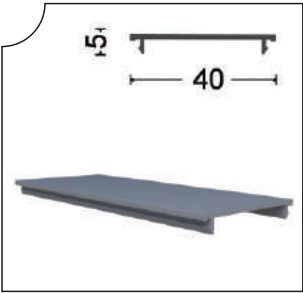

GYTN-1711 Yan Dikme Kapağı
Side Cover Profile

Ağırlık/Weight
0.194 kg/m

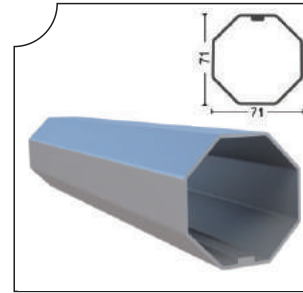

GYTN-2000 70'lik Sekizgen Sac Boru
Octagonal Aluminum Tubing



Aksesuarlar Accessories

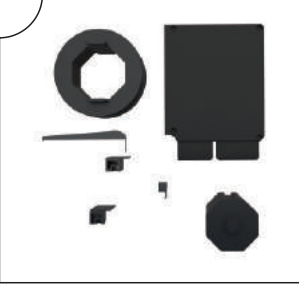

GYTN-2001 Kayışlı Giyotin Aksesuar Takımı
Guillotine Accessories - (For Steel Strap)

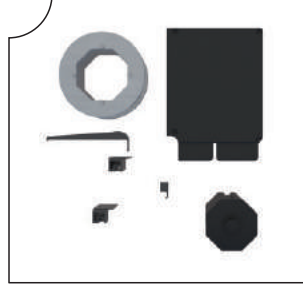

GYTN-2002 Zincirli Giyotin Aksesuar Takımı
Guillotine Accessories - (For Steel Chain)



GYTN-2004 Çelik Kayış
Steel Strap



GYTN-2005 Çelik Zincir
Steel Chain

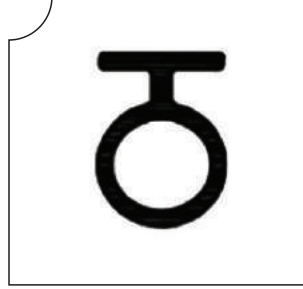

GYTN-2003 Balon Conta
Rubber Seal



KLFTL-1004 67x1000 Kıl Fıtl
Brush Seal 67x1000

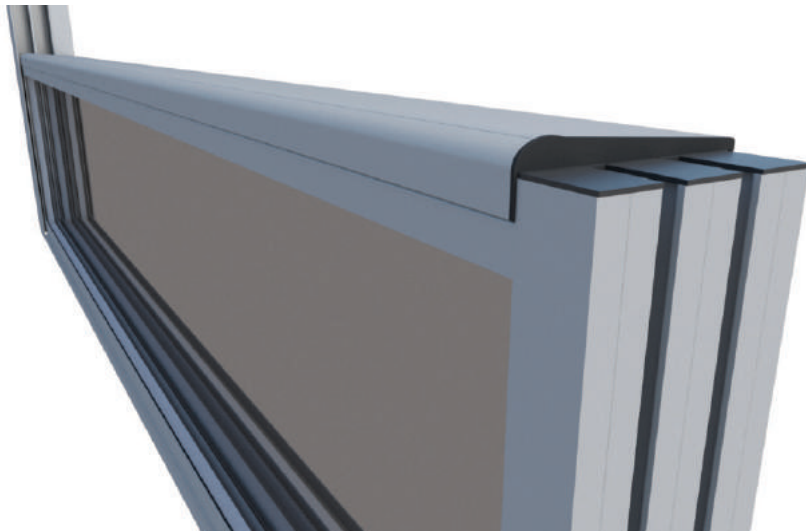

Giyotin Cam / Guillotine Glass

Klasik Giyotin Cam Isıcamlı & 8 mm
Classic Guillotine Glass (Double Glass & 8 mm)

Aksesuarlar Accessories



2120-130-103-0 Becker L 120 NM (PSF+) Motor
Becker Guillotine Engine



2080-130-130-0 Becker L 80 NM (PSF+) Motor
Becker Guillotine Engine



4034-000-201-0 Becker 1 Kanallı Kumanda
Becker 1 Connection Remote Control



4034-000-202-0 Becker 5 Kanallı Kumanda
Becker 5 Connection Remote Control



4034-000-203-0 Becker 10 Kanallı Kumanda
Becker 10 Connection Remote Control



MOSEL70RE120 Mosel 70-120 Elk. Alicılı Motor
Mosel Guillotine Engine



MOSEL70R120 Mosel 70-120 Alicılı Motor
Mosel Guillotine Engine



MOSEL70RE140 Mosel 70-140 Elk. Alicılı Motor
Mosel Guillotine Engine



MOSEL70R140 Mosel 70-140 Elk. Alicılı Motor
Mosel Guillotine Engine



RCOTMDC104 Mosel 1 Kanallı Kumanda
Mosel 1 Connection Remote Control



RCOTMDC105 Mosel 5 Kanallı Kumanda
Mosel 5 Connection Remote Control

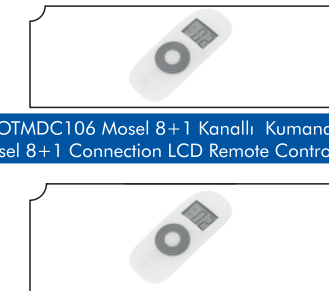

RCOTMDC106 Mosel 8+1 Kanallı Kumanda
Mosel 8+1 Connection LCD Remote Control



RCOTMDC107 Mosel 14+1 Kanallı Kumanda
Mosel 14+1 Connection LCD Remote Control

Montaj Installation

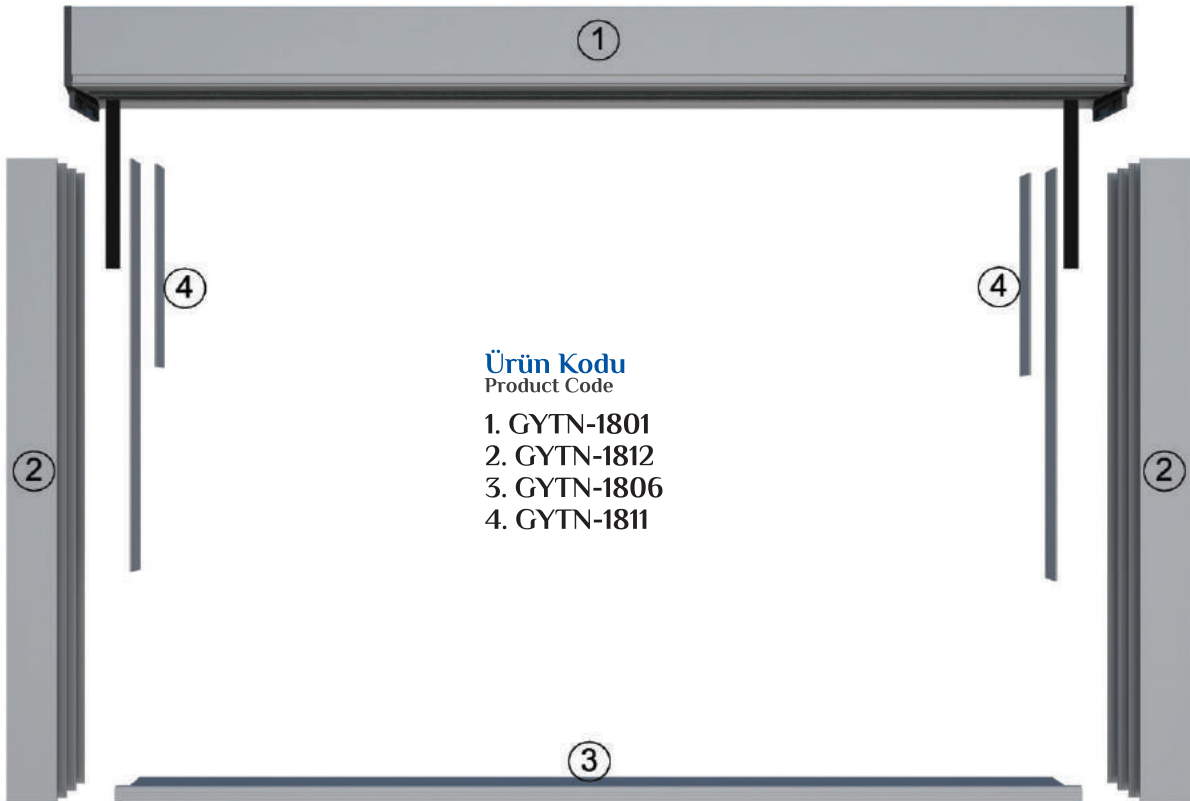
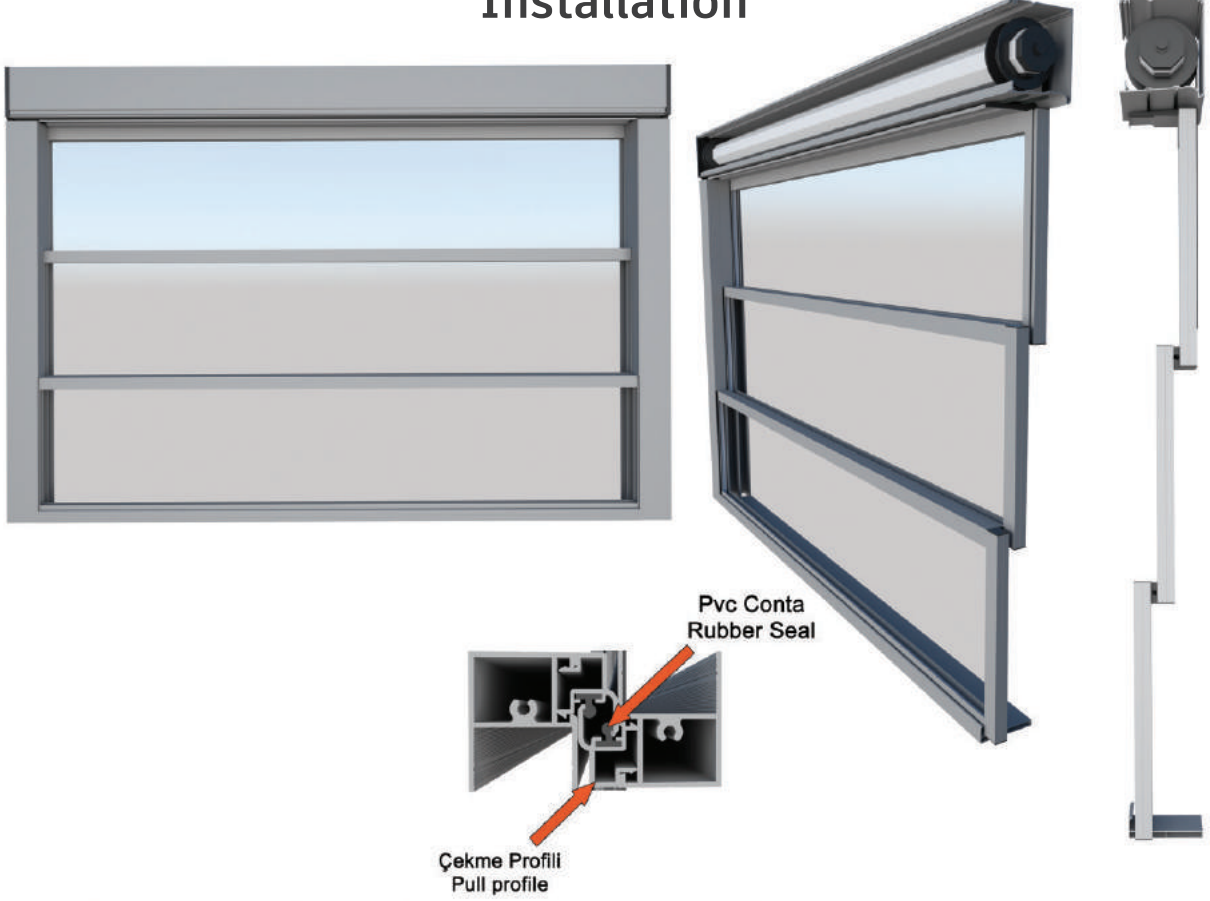

Ürün Kodu Product Code

1. GYTN-1801
2. GYTN-1812
3. GYTN-1806
4. GYTN-1811

Klasik Giyotin Cam Isıcamlı & 8 mm
Classic Guillotine Glass (Double Glass & 8 mm)

Montaj Installation

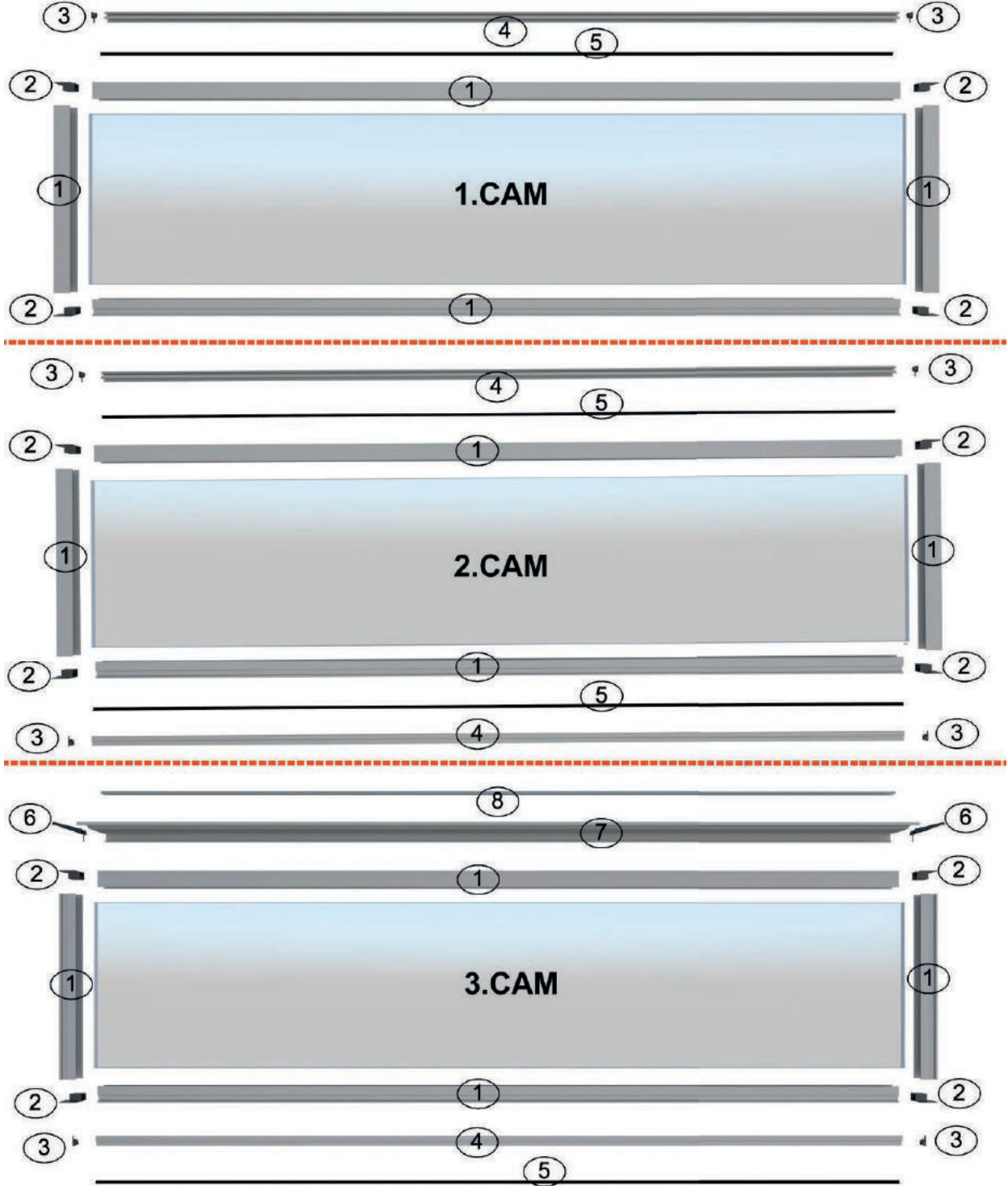

Ürün Kodu
Product Code

1. GYTN-1801
2. GYTN-1812
3. GYTN-1806
4. GYTN-1811



Çelik Kayışlı Sistem Steel Strap System

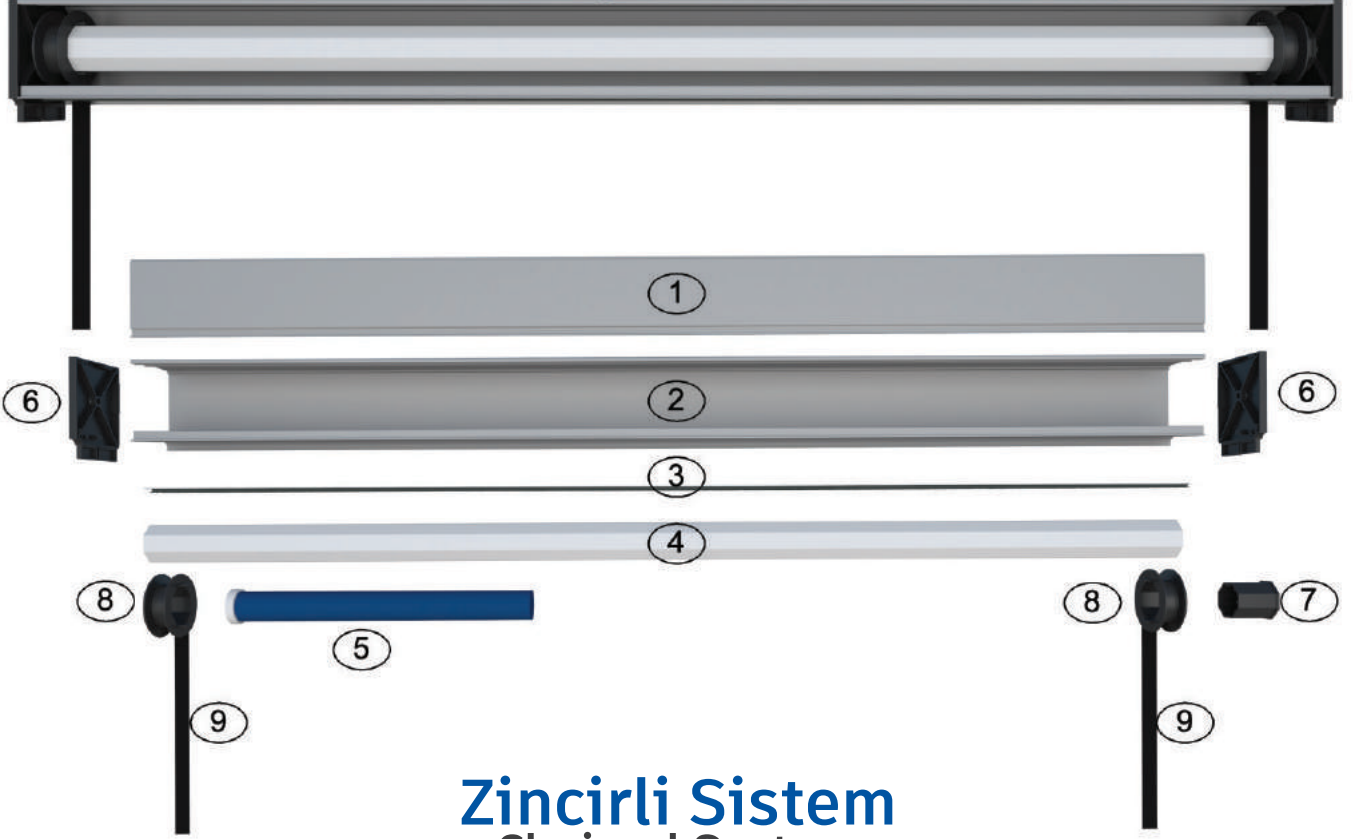

Zincirli Sistem Chained System

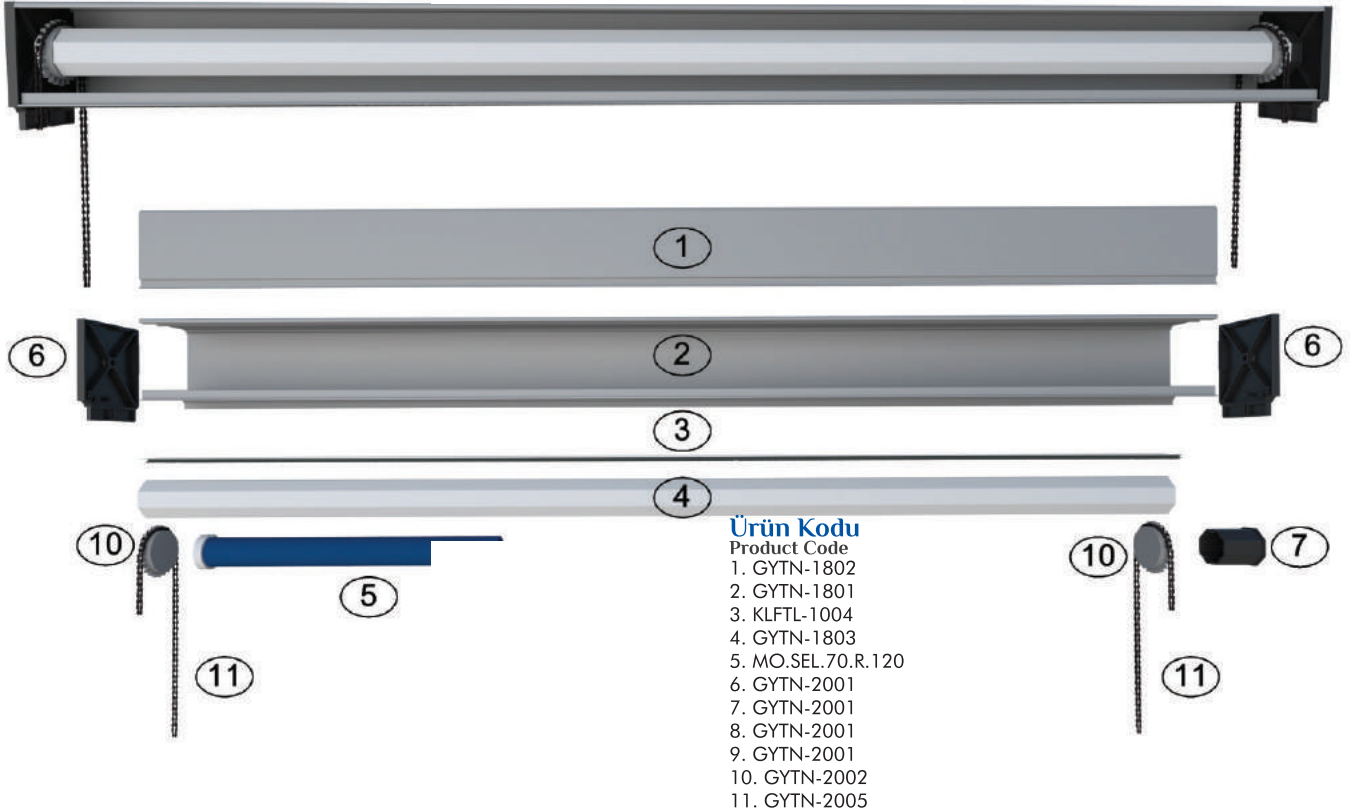

Ürün Kodu

- Product Code
1. GYTN-1802
2. GYTN-1801
3. KLFTL-1004
4. GYTN-1803
5. MO.SEL.70.R.120
6. GYTN-2001
7. GYTN-2001
8. GYTN-2001
9. GYTN-2001
10. GYTN-2002
11. GYTN-2005

Giyotin Cam / Guillotine Glass



Klasik Giyotin Cam Isıcamlı & 8 mm
Classic Guillotine Glass (Double Glass & 8 mm)



0266 392 1258



ozgulleraluminyum



ozgulleraluminyum.com.tr



ÖZGÜLLER
ALUMINIUM SYSTEMS



0266 392 1258



ozgulleraluminyum



ozgulleraluminyum

ozgulleraluminyum.com.tr